

Fundamentals of RF and Microwave Noise Figure Measurements

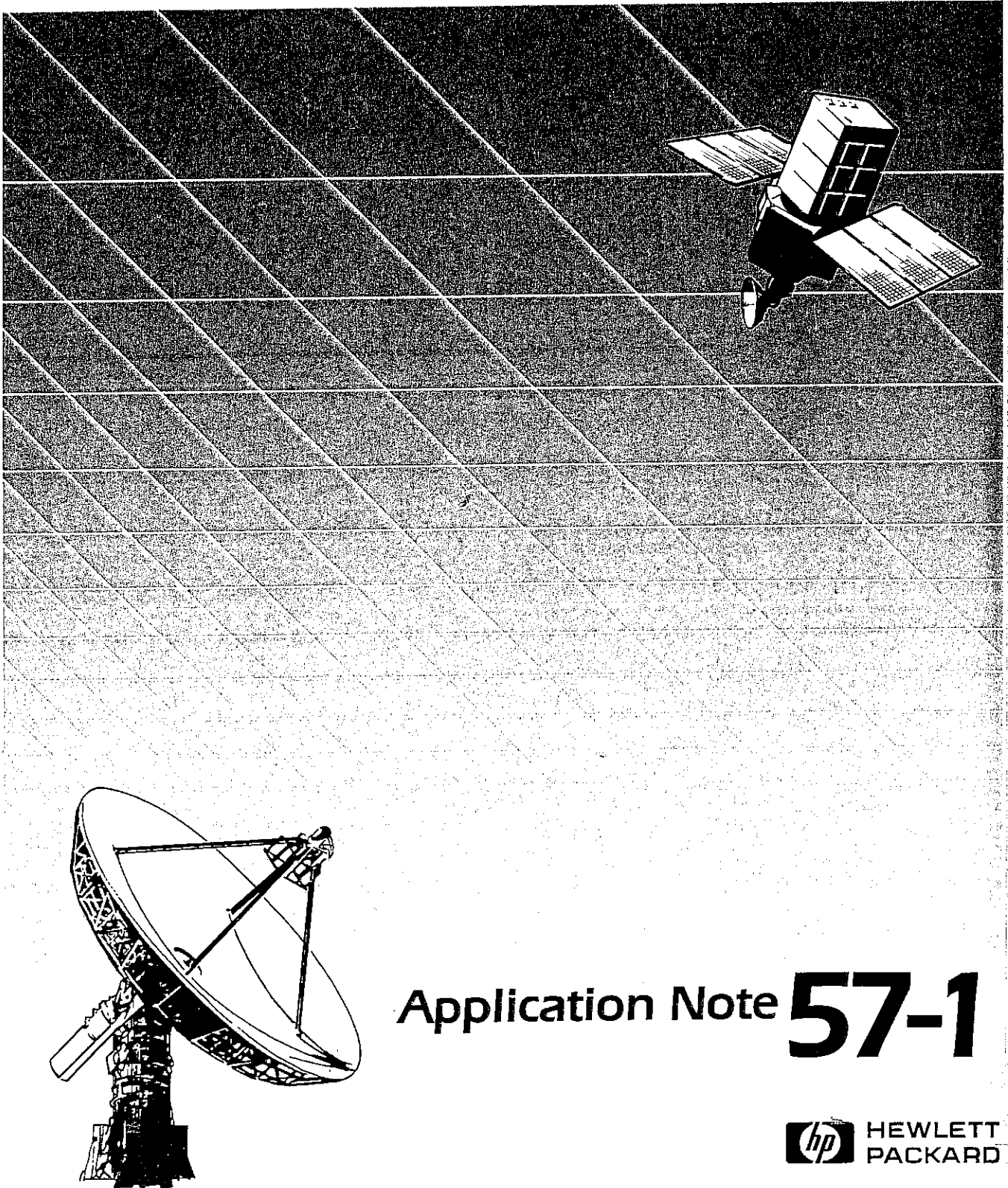

Application Note **57-1**

 HEWLETT
PACKARD

Application Note 57-1

Fundamentals

of RF and Microwave

Noise Figure Measurements

Table of Contents

1. Noise Characteristics of Two-port Networks	3
Introduction	3
Kinds of Noise	3
Thermal Noise	4
Shot Noise	4
The Concept of Noise Figure	5
The Importance of Noise Figure Measurement	6
Noise Characteristics of Linear Two-port Networks	7
Noise Figure With the Straight Line	8
T_e With the Straight Line	8
Noise Figure and T_e Compared	9
Gain and Available Gain	10
Measurement of Noise Figure and T_e	11
Some Typical Noise Figures	12
2. The Measurement of Noise Characteristics	15
Noise Sources	15
Noise Figure Meters	16
ENR Variations with Frequency	16
Cold Noise Source Temperature	16
Second Stage Noise Contribution	17
Frequency Converters	17
Mixers	18
Local Oscillators	19
IF Amplifiers	20
Y-Factor Measurement	20
Hot/Cold Measurement	21
Signal Generator Method	22
3. Appendix	25
4. Glossary	29
Symbols and Glossary Terms	29
References	38
Checklist, Etc.	40

1. Noise Characteristics of Two-port Networks

Introduction

Modern receiving systems must often process very weak signals, but the noise added by the system components tends to obscure those very weak signals. Sensitivity, SINAD, and noise figure are popular system parameters that characterize the ability to process low-level signals. Of these parameters, noise figure is unique in that it is suitable not only for characterizing the entire system but also the system components such as the preamplifier, mixer, and IF amplifier that make up the system. By controlling the noise figure and gain of system components, the designer directly controls the noise figure of the overall system. Once the noise figure is known, system sensitivity can be easily estimated from system bandwidth. Noise figure is often the key parameter that differentiates one system from another, one amplifier from another, and one transistor from another. Such widespread application of noise figure specifications implies that highly repeatable and accurate measurements between vendors and their customers are very important.

The reason for measuring noise properties of networks is to minimize the problem of noise generated in receiving systems. The noise obscures weak signals. One approach to overcome noise is to make the weak signal stronger. This can be accomplished by raising the signal power transmitted in the direction of the receiver, or by increasing the amount of power the receiving antenna intercepts, i.e., by increasing the aperture of the receiving antenna. Raising antenna gain, which usually means a larger antenna, and raising the transmitter power are eventually limited by government regulations, engineering considerations or economics. The other approach is to minimize the noise generated within receiver components. Noise measurements are key to assuring that the added noise is minimal. Once noise joins the signals, receiver components can no longer distinguish noise in the signal frequency band from legitimate signal fluctuations. The signal and noise get processed together. Subsequent raising of the signal level with gain, for example, will raise the noise level an equal amount.

The need for highly repeatable, accurate and meaningful measurements has, over the years, revealed several subtle measurement effects, that require correction factors, and a host of noise related terms. These have contributed to a mystique about noise figure measurements that brings anxiety to the neophyte. The HP 8970A Noise Figure Meter uses a microprocessor to perform the tedious calculations, and corrects for many subtle effects that were formerly accepted as measurement errors or were corrected manually by highly skilled people. The major goal of this application note is to develop the reader's intuitive understanding of noise measurements and to build a general

knowledge about the effects of noise. Thus this note, along with the 8970A Noise Figure Meter, hopes to remove the mystique and replace the neophyte's anxiety with confidence, thereby enhancing the art of making proper noise figure measurements.

This application note is the first of a series about noise and its measurement in radio frequency equipment. This first note discusses the fundamentals of noise measurement. Much of what is discussed is either background material or material that is common to most noise figure measurements. Other application notes will discuss more specific topics.

The introductory chapter discusses why noise and its measurement are important, and the concepts that lead to the noise behavior of networks. The next chapter describes various measurement methods, old and new, and discusses the equipment needed for noise characterization. The appendix contains derivations of several noise figure relations that sometimes puzzle the newcomer. The last part of this application note is an extensive glossary of noise related terms.

The glossary serves several purposes. It is a convenient reference to noise figure terms which can be consulted as needs arise. The more usual treatment, not followed here, progresses from simple terms to more complicated terms or most general terms to most particular. Such developments pressure the inquisitive reader to read from beginning to end rather than to look up terms as his needs arise. Some of the terms in the glossary go beyond a dictionary type of definition to include considerable background and analysis, e.g., available gain, insertion gain, power gain and transducer gain. Some of the descriptions are paraphrased from referenced documents in an attempt to increase initial comprehension. The reader is encouraged to skim through the glossary to see what terms are there and to study the various entries in depth as necessary.

A list of references occurs at the end of the glossary. Throughout the text of this note, numbers in rectangular brackets pertain to that list of references.

Kinds of Noise

The noise being characterized by noise measurements consists of spontaneous fluctuations caused by ordinary phenomena in the electrical equipment. Two principal types of such noise are thermal noise and shot noise. Thermal noise arises from vibrations of conduction electrons and holes due their finite temperature. Some of the vibrations have spectral content within the frequency

band of interest and contribute noise to the signals. Shot noise arises from the quantized nature of current flow.

Thermal Noise

Thermal noise refers to the kinetic energy of a body of particles as a result of its finite temperature. If some particles are charged (ionized), vibrational kinetic energy may be coupled electrically to another device if a suitable transmission path is provided. The power available, i.e. the maximum rate at which energy can be removed from the body, is kTB where k is Boltzmann's constant (1.38×10^{-23} joules/kelvin), T is the absolute temperature, and B is the bandwidth of the transmission path [18, 26]. The units of kTB are usually joules/second which are the same as watts.

A brief examination of kTB shows that each of the factors makes sense. Boltzmann's constant k gives the average mechanical energy per particle that can be coupled out by electrical means per degree of temperature. Boltzmann's constant is related to the universal gas constant (R of the gas law that states $pV=NRT$). R gives the energy per mole of gas per degree, but k gives the average energy per particle per degree. The ratio R/k is equal to the number of particles in a mole which, of course, is Avogadro's number (6.02×10^{26}). Boltzmann's constant is thus a conversion constant between two forms of expressing energy — in terms of absolute temperature and in terms of joules.

That the power available should depend directly on temperature is obvious. The more energy that is present in the form of higher temperature or larger vibrations, the more energy that it is possible to remove per second.

That bandwidth should be part of the expression is, perhaps, not immediately obvious. Consider the example of a transmission band limited to the 10 to 11 Hz range. Then only that small portion of the vibrational energy in the 10 to 11 Hz band can be coupled out. The same amount of energy applies to the 11 to 12 Hz band (because the energy is evenly distributed across the frequency spectrum). If, however, the band were 10 to 12 Hz, then the total energy of the two Hz range, twice as much, is available to be coupled out. Thus it is reasonable to have bandwidth, B , in the expression for available power.

It should be emphasized that kTB is the power available from the device. This power can only be coupled out into an optimum load, i.e., a complex-conjugate impedance that is at absolute zero so that it does not send any energy back.

The thermal noise power available, kTB , although dependent on bandwidth, is independent of frequency. The glossary gives a more exact expression that shows the very slight frequency dependence of the power available. The power density is constant to within 1% up to 100 GHz, and

to within 10% up to 1000 GHz. Since 100 GHz covers most electrical equipment, the simple expression, kTB , will be used.

It might seem that the power available should depend on the physical size or on the number of charge carriers, i.e., the resistance. A larger body, after all, contains more total energy per degree and more charged particles would seem to provide more paths for coupling energy. It is easy to show with a counter example that the power available is independent of the size or of the resistance. Consider a system consisting of a large object at a certain temperature, electrically connected to a small object at the same temperature. If there were a net power flow from the large object to the small object, then the large object would become cooler and the small object would become warmer. This violates our common experience — not to mention the second law of thermodynamics. So the power from the large object must be the same as that from the small object. The same reasoning applies to a large resistance and small resistance instead of a large and small object.

This brings up the point that if a source of noise is emitting energy it should be cooling off. Such is generally the case, but for the problems in electrical equipment, any energy removed by noise power transfer is so small that it is quickly replenished by the environment at the same rate. This means that sources of noise are in thermal equilibrium with their environment.

For a more thorough treatment of thermal noise, consult the references by Johnson [18] and Nyquist [26].

Shot Noise

Shot noise is caused by the quantized and random nature of current flow. Current is not continuous but quantized, being limited by the smallest unit of charge ($e=1.6 \times 10^{-19}$ coulombs). Particles of charge, furthermore, also flow with random spacing. The arrival of one unit of charge at a boundary is independent of when the previous unit arrived or when the succeeding unit will arrive. When dc current I_0 flows, the average current is I_0 , but that does not indicate what the variation in the current is or what frequencies are involved in the random variations of current. Statistical analysis of the random occurrence of particle flow yields (see, for example, Van der Ziel [33]) that the mean square current variations are uniformly distributed in frequency and have a spectral density of

$$\overline{i_n^2}(f) = 2e I_0 A^2/\text{Hz} \quad (1-1)$$

This formula holds for those frequencies which have periods much less than the transit time of carriers across the device. More exactly, the period must be much less than the width of each current pulse. The noisy current flowing

through a load resistance forms the power variations known as shot noise.

Other random phenomena occur that are quantized in nature and can be statistically analyzed in the manner of shot noise. Examples are the generation and recombination of hole/electron pairs in semiconductors (G-R noise), and the division of emitter current between the base and collector in transistors (partition noise).

A very important source of noise occurs in avalanche diodes because such devices are used as reference sources for measurement. Here a carrier achieves enough energy so that, upon collision with the crystal lattice, it is able to generate another hole/electron pair. Some mobile carriers generate two pairs, some three, and then those can generate other pairs, etc. The multiplication factor for the free-charge generation varies randomly and is also quantized. The noise power associated with the avalanche diode tends to be inversely proportional to current and somewhat dependent on frequency. The noise power vs. frequency relation depends on the current being conducted (see Haitz [11,12]).

Thus there are many causes of random noise in electrical devices. Noise characterization usually refers to the combined effect from all the causes in a component. The combined effect is often referred to as if it all were caused by thermal noise. Referring to a device as having a certain noise temperature does not mean that the component is that physical temperature, but merely that its noise power is equivalent to a thermal source of that temperature.

The noise of this application note does not include human generated interference, although such interference is very important when receiving weak signals. This note is not concerned with noise from ignition, sparks, or with undesired pick-up of spurious signals. Nor is this note concerned with erratic disturbances like electrical storms in the atmosphere. Such noise problems are usually resolved by techniques like relocation, filtering, and proper shielding. Yet these sources of noise are important here in one sense — they upset the measurements of the spontaneous noise this note is concerned with. For this reason, accurate noise figure measurements must often be performed in shielded rooms.

The Concept of Noise Figure

Before showing the importance of accurate noise measurement, it is necessary to define the most popular quality factor for noise performance, noise figure. Harold Friis [7] defined the noise figure F of a network to be the ratio of the signal-to-noise ratio at the input to the signal-to-noise ratio

at the output. Thus the noise figure of a network is the decrease or degradation in the signal-to-noise ratio as the signal goes through the network. A perfect amplifier would amplify the noise at its input along with the signal. (The source of input noise is often thermal agitation of free electrons in the atmosphere acting like signal to the amplifier.) A realistic amplifier, however, also adds some extra noise from its own components and degrades the signal-to-noise ratio. A low noise figure means that very little noise is added by the network. The concept of noise figure only fits networks that process signals — ones that have at least one input port and one output port. This note is mainly about two-port networks.

It might be worthwhile to mention what noise figure does not characterize. Noise figure is not a quality factor of networks with one port; it is not a quality factor of terminations or of oscillators. Oscillators indeed generate noise and have their own quality factors like "carrier to noise ratio" and "single-sideband phase noise in a one hertz bandwidth, X hertz from the carrier". But receiver noise generated in the sidebands of the local oscillator that drives the mixer, acts like noise that gets added by the mixer. Such added noise increases the noise figure of the receiver.

Noise figure also has nothing to do with modulation. It is independent of the modulation format and of the fidelity of modulators and demodulators. Noise figure is, therefore, unlike SINAD, which is often used to indicate the quality of FM receivers.

Noise figure should be thought of as separate from gain. Once noise is added to the signal, subsequent gain amplifies signal and noise together and does not change the signal-to-noise ratio.

Noise figure serves best for the low-signal-level portions of a system. It is normally not a useful quality of high-power stages. Once the signal level achieves a high level, added noise is usually small in comparison and is no longer a source of aggravation or uncertainty. In analysis this shows up in the cascade effect (see glossary). The effect on noise figure of noise added by a device toward the output of a system is divided by the gain that precedes that device. Since preceding gain is large by the time the signal reaches the high-power stages, the effect of added noise is small.

Figure 1-1(a) shows an example situation at the input of an amplifier. The depicted signal is 40 dB above the noise floor. Figure 1-1(b) shows the situation at the amplifier output. The amplifier's gain has boosted the signal by 20 dB. It also boosted the input noise level by 20 dB and then added its own noise. The output signal is now only 30 dB above the noise floor. Since the degradation

in signal-to-noise ratio is 10 dB, the amplifier has a 10 dB noise figure.

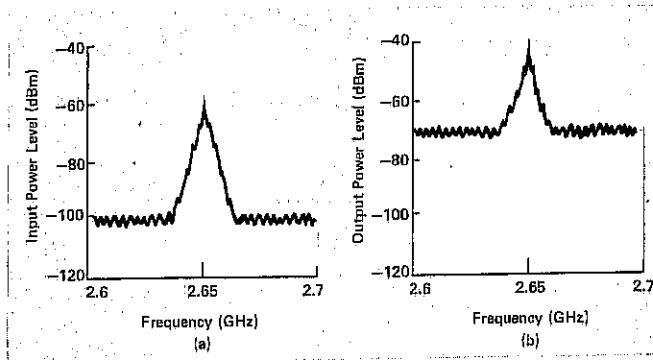

Figure 1-1. Typical signal and noise levels vs. frequency (a) at an amplifier's input and (b) at its output. Note that the noise level rises more than the signal level due to added noise from amplifier circuits. This relative rise in noise level is expressed by the amplifier noise figure.

Note that if the input signal level were 5 dB lower (35 dB above the noise floor) it would also be 5 dB lower at the output (25 dB above the noise floor), and the noise figure would still be 10 dB. Thus noise figure is independent of the input signal level.

A somewhat subtle effect will now be described. The degradation in a network's signal-to-noise ratio is dependent on the temperature of the source that excites the network. To see why that is true, the ratio of the signal-to-noise ratios, i.e., the noise figure, is

$$\begin{aligned}
 F &= \frac{S_i/N_i}{S_o/N_o} \\
 &= \frac{S_i/N_i}{G_a S_i / (N_a + G_a N_i)} \\
 &= \frac{N_a + G_a N_i}{G_a N_i} \quad (1-2)
 \end{aligned}$$

where S_i and N_i represent the signal and noise levels available at the input to the device under test (DUT), S_o and N_o represent the signal and noise levels available at the output, N_a is the noise added by the DUT, and G_a is the available gain of the DUT. Equation (1-2) shows the dependence on noise at the input N_i . The input noise level is usually thermal noise from the source and is referred to by kT_b . Friis [7] suggested a reference source temperature of 290K (denoted by T_o), which is equivalent to 16.8°C and 62.3°F. This temperature is close to the temperature seen by receiving antennas directed across the atmosphere at the transmitting antenna. The power spectral density kT_o , furthermore, is the even number 4.00×10^{-21} watts per hertz of bandwidth (-174 dBm/Hz). The IRE (forerunner of the

IEEE) adopted 290K as the standard temperature [6] for determining noise figure. Then equation (1-2) becomes

$$F = \frac{N_a + kT_o B G_a}{kT_o B G_a} \quad (1-3)$$

which is the definition of noise figure adopted by the IRE.

Noise figure is generally a function of frequency but it is usually independent of bandwidth (so long as the measurement bandwidth is narrow enough to resolve variations with frequency). Noise powers N_a and N_i of equation (1-2) are each proportional to bandwidth. But the bandwidth in the numerator of (1-2) cancels with that of the denominator — resulting in noise figure being independent of bandwidth.

In summary, the noise figure of a DUT is the degradation in the signal-to-noise ratio as a signal passes through the DUT. The specific input noise level for determining the degradation is that associated with a 290K source temperature. The noise figure of a DUT is independent of the signal level so long as the DUT is linear. Because of the need for linearity, any AGC circuitry must be deactivated for noise figure measurements.

The IEEE Standard definition of noise figure, eq (1-3), states that noise figure is the ratio of the total noise power output to that portion of the noise power output due to noise at the input when the input source temperature is 290K. It is obviously related to the Friis definition by the above arguments.

The Importance of Noise Figure Measurement

The signal-to-noise ratio at the output of receiving systems is a very important criterion in communication systems. We frequently experience the difficulty of listening to a radio signal in the presence of noise. The ability to interpret the audio information, however, is difficult to quantify because it depends on such human factors as familiarity with language, the nature of message, fatigue, training, and experience. Noise figure and sensitivity are measurable figures of merit. Noise figure and sensitivity are closely related (see Sensitivity in the glossary). For digital communication systems, a quantitative reliability measure is often stated in terms of bit error rate (BER) or the probability $P(e)$ that any received bit is in error. BER is related to noise figure in a non-linear way. As the S/N ratio decreases gradually, for example, the BER increases suddenly near the noise level where 1's and 0's become confused. Noise figure shows the health of the system but BER shows whether the system is dead or alive. Figure 1-2, which shows the probability of error vs. signal-to-noise ratio for several types of digital modulation, indicates that

BER changes by several orders of magnitude for only a few dB change in signal-to-noise ratio.

reduction in noise figure has about the same effect as increasing the antenna diameter by 10%. But increasing the diameter could change the design and significantly raise the cost of the antenna steering mechanism and support structure.

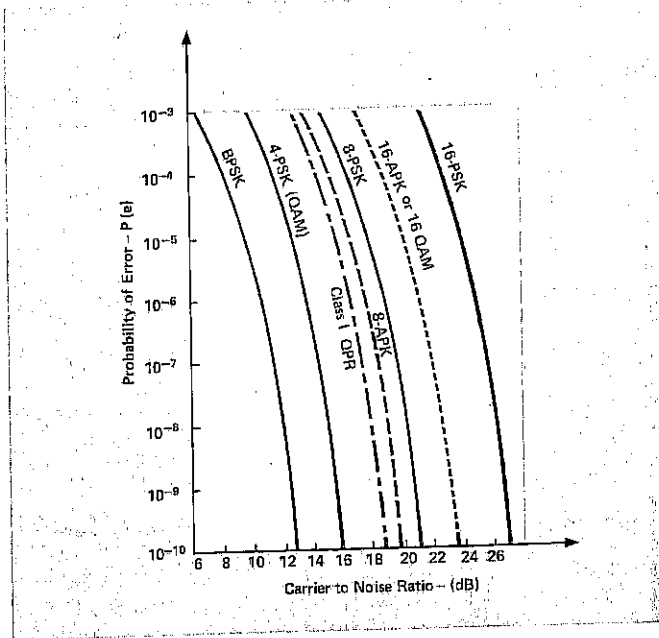

Figure 1-2. Probability of error, $P(e)$, as a function of carrier-to-noise ratio, C/N (which can be interpreted as signal-to-noise ratio), for various kinds of digital modulation. From Kamilo Feher, *DIGITAL COMMUNICATIONS: Microwave Applications*, ©1981, p. 71. Reprinted by permission of Prentice-Hall, Inc., Englewood Cliffs, N. J.

As explained above, the output signal-to-noise ratio depends on two things — the input signal-to-noise ratio and the noise figure. In terrestrial systems the input signal-to-noise ratio is a function of the transmitted power, transmitter antenna gain, atmospheric transmission coefficient, atmospheric temperature, receiver antenna gain, and receiver noise figure. Lowering the receiver noise figure has the same effect on the output signal-to-noise ratio as improving any one of the other quantities.

At the system design level, consider the example of lowering a receiver's noise figure from 10 dB to 7 dB by adding an ordinary-quality, low-noise preamplifier in front of the receiver's mixer. This has the same effect on the signal-to-noise ratio as doubling the transmitter power. Doubling the transmitter power, if allowed, often doubles the price — more expensive than the ordinary low-noise preamp.

In the case of a production line that produces receivers, it may be quite easy to reduce the noise figure 1 dB by adjusting impedance levels or selecting transistors. That 1 dB

Noise Characteristics of Linear Two-Port Networks

Although noise figure was described above, a deeper treatment of noise behavior is helpful to understand and clarify the many noise figure terms and concepts in popular use, as well as to conceive, analyze, and refine noise measurement setups.

At the low power levels of concern here, amplifiers, mixers, input stages of receivers, passive networks, and transistors operate in the linear region. This means the power out is proportional to the power in. If the input signal is set to zero, but the source impedance remains, the power input to devices is thermal noise from the source impedance. Linear devices will exhibit a straight line power output characteristic vs. source temperature as pictured in **Figure 1-3**. In **Figure 1-3**, the Y axis indicates the noise power at the output of a DUT and the X axis indicates the absolute temperature of the source impedance that excites the DUT. At the origin of the X axis, where the source

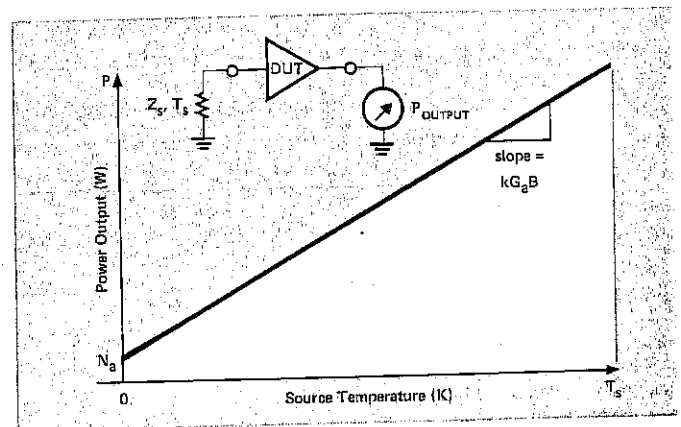

Figure 1-3. The straight-line power output vs. source temperature characteristic of linear, two-port devices. For a source impedance with a temperature of absolute zero, the power output consists solely of added noise N_a from the device under test (DUT). For other source temperatures the power output is increased by thermal noise from the source amplified by the gain-bandwidth characteristic of the DUT.

temperature is absolute zero, electron vibrations in the source impedance are non-existent and the noise power output from the DUT consists solely of noise generated within or added by the DUT, N_a . For any other source temperature T_s , the electron vibrations in the source act like signal to the DUT with available input noise power density, kT_s watts/Hz (k is Boltzman's constant $=1.38 \times 10^{-23}$ joules/kelvin). kT_s is about -174 dBm/Hz at room temperature. The input noise power gets amplified by the gain-bandwidth product of the DUT to form additional output noise power, bringing the total output to $N_a + kT_s G_a B$. The straight-line characteristic of noise power output versus source temperature has slope kGB and Y-axis intercept N_a .

Noise Figure With the Straight Line

The straight-line characteristic is a complete description of noise performance. But such graphs are difficult to communicate. It is more common to find one or two figures of merit. One obvious figure of merit for this case is gain (proportional to the slope of the straight line). A second figure of merit, popularized in the 1940's and 50's, is noise figure. Systems of that era were terrestrial, and the noise received by antennas corresponded to atmospheric temperatures (about 290K). For this reason, noise figure concentrates on describing the noise characteristic at a source temperature of 290K (Figure 1-4). The basis for defining noise figure is equation (1-3) which was already discussed but is repeated here

$$F = \frac{N_a + kT_0 BG_a}{kT_0 BG_a} \quad (1-3)$$

This equation shows that noise figure F , is the ratio of total noise power output, to that portion of the power output engendered by the 290K source temperature (the height of the shaded area in Figure 1-4). As indicated in the glossary, the numerical ratio is sometimes called noise factor and the ratio in dB is called noise figure. More often, however, "noise figure" is used for both forms. There should be no confusion as to which is being considered because the units "dB" accompany the result of taking $10 \log$ (ratio).

T_e With the Straight Line

Satellite receivers began to come into being in the 1960's and input noise levels to antennas fell toward the background temperature of deep space (≈ 4 K). Device technology, furthermore, improved to the point where the noise added was less than 25% of $kT_0 G_a B$ (noise figures less than 1 dB). For some of these applications, noise figure and its reference to 290K, has given way to another figure of merit, T_e , the effective input noise temperature. Consider that a completely noise-free device, one that adds no noise of its own, would have a straight-line noise characteristic that goes through the origin as shown in Figure 1-5. If the Y-axis intercept, N_a , of the actual DUT is projected hori-

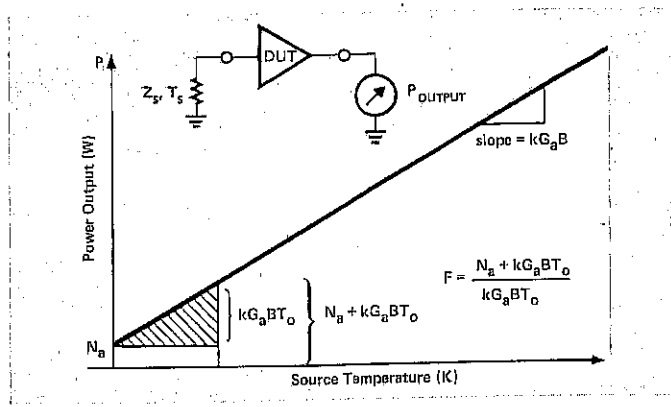

Figure 1-4. Noise figure shows the behavior at standard temperature T_0 (≈ 290 K). Noise figure is the ratio of the total power output ($N_a + kT_0 BG_a$) to that portion that is due to the amplified input noise power ($kT_0 BG_a$). Noise figure is usually expressed in dB.

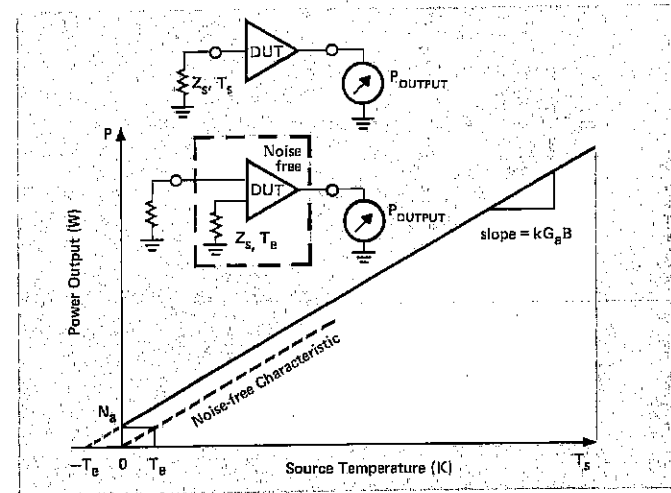

Figure 1-5. Effective input noise temperature T_e shows how hot the source impedance driving a perfect (noise-free) device would have to be to contribute the same noise as the added noise of the DUT. It also turns out that $-T_e$ is the X-axis intercept of the straight-line noise characteristic.

zontally to the ideal device characteristic and then projected down, the point T_e occurs on the X axis. In other words, T_e is the source temperature whose noise power, multiplied by the gain-bandwidth product, equals the noise added.

Another interpretation of T_e is to translate the ideal straight-line characteristic (the one that goes through the origin) to the left until it is superimposed on the actual DUT characteristic. The distance of left translation is T_e .

This also means the extrapolated X-axis intercept of the DUT straight-line characteristic is the negative of T_e .

T_e is a much better quality factor pertaining to noise than N_a because N_a is directly dependent on the gain of the DUT. N_a is affected, for example, by gain that occurs toward the output of the DUT after a lot of gain at the input. Such gain varies the slope of the straight line and the Y-axis intercept, N_a , but not the X-axis intercept, $-T_e$.

The above descriptions of T_e and F referred to the gain-bandwidth product of the DUT. The power measurement equipment at the output was assumed to be broadband. Consider, however, having a narrowband, tunable power meter. Then the bandwidth and frequency of measurement are determined by the power meter. Different straight-line noise characteristics would likely be measured for different power meter frequencies showing that T_e and F are functions of frequency. The slope of the straight line is proportional to the bandwidth of power meter, the gain of the power meter, and the gain of the DUT. The characteristic at an individual frequency is often emphasized by the

term "spot noise figure". Very broadband noise figures are sometimes distinguished by the term "average noise figure".

Noise Figure and T_e Compared

When people learn that noise figure and T_e characterize the noise performance of devices, they often feel compelled to select one of those figures of merit as the more useful. But there is no dominant use of one term over the other. For terrestrial applications, noise figure is almost universally used. This is probably due to tradition and due to T_e having inconveniently large numerical values (≈ 600 to $3000K$). For space applications, however, T_e is more common. The range of values for T_e (≈ 35 to $150K$) is more convenient and has adequate resolution. Noise figure is approximately 0.5 to 1.5 dB for space applications. But noise figure needs to be given to two decimal places to have the resolution that people believe they need. The following table compares the traits of each.

F	T_e
The concept of S/N degradation for a 290K source temperature is sound, but it is only valid for terrestrial systems.	The concept of effective input noise temperature is comparable to the actual source temperature to judge degradation.
290K reference temperature for the source temperature is not appropriate for deep space applications.	No reference temperature is needed.
dB measurement gives a convenient range of numbers (0.3 to 1.5 dB for deep space, 5 to 10 dB for terrestrial applications).	The numbers involved are sometimes inconveniently large (≈ 600 to $2500K$) for terrestrial systems.
Measurement uncertainties are approximately constant in dB for the usual range of noise figures.	Measurement uncertainties and their effect on system operation depend on T_e and the source temperature of the application.
Algebraic expressions for noise figure are complicated by T_o 's and -1 's.	Algebraic expressions for T_e are simpler than for noise figure.
Input noise at spurious response frequencies obscures weak signals and therefore degrades the noise figure. The usual measurement techniques, however, measure all responses as information bands instead of spurious bands. Hence the measured noise figure must often be corrected.	Input noise at spurious response frequencies has no direct effect on T_e even though that noise degrades weak signals in the information band. Measured values of T_e do not require correction.
A graphical interpretation of noise figure on the straight-line noise characteristic is somewhat obscure.	Considering $-T_e$ as the X-axis intercept, the straight-line noise characteristic is elegant and pleasing.

More needs to be said about degradation of the signal-to-noise ratio. In terrestrial systems, where the noise power at the input corresponds to about 290K, noise figure properly gives the degradation. Decreasing the noise figure by 0.1 dB, for example, has the same effect on signal fidelity as increasing the transmitter power by 0.1 dB.

In earth station receivers for satellites, however, where the noise power at the input corresponds to about 30K, noise figure under-represents the signal-to-noise ratio degradation. According to **Figure 1-6**, decreasing noise figure from 1.0 dB to 0.9 dB (T_e from 75K to 67K), for example, causes the signal-to-noise ratio degradation to change from 5.44 dB to 5.08 dB. This is equivalent to increasing the transmitter power by 0.36 dB. The 290K reference temperature, inappropriate for space applications, is the cause of nonequivalence. Another interpretation of this example is that noise figure measurement accuracy is very important for satellite receivers. A noise figure measurement uncertainty of ± 0.1 dB, which requires the best of equipment, a well-behaved DUT, and the most exacting technique, is equivalent to a transmitter power variation of ± 0.35 dB.

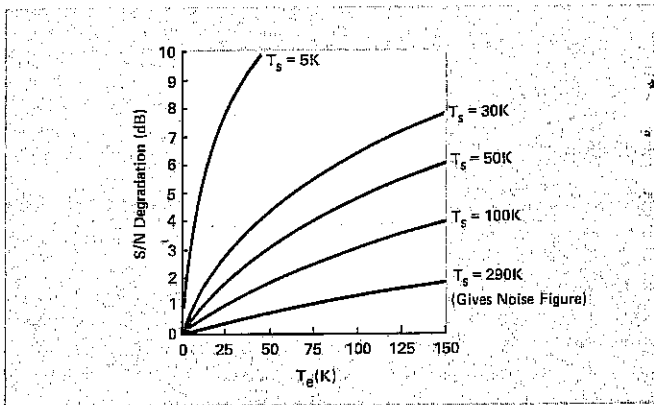

Figure 1-6. Degradation in the S/N ratio vs T_e of a device for various values of temperature for the source impedance. Noise figure is defined for a source temperature of 290K.

Gain and Available Gain

Each kind of gain is discussed in the glossary but some comments about each may eliminate some confusion. The popular types of gain are the forward transmission coefficient $|S_{21}|^2$, power gain G , available (power) gain G_a , and transducer (power) gain G_t . Insertion Gain G_i will also be discussed.

$|S_{21}|^2$ is the ratio of power incident upon the load to the power incident upon the input of the DUT when the source and load are nonreflecting (usually equal to 50 ohms).

Different source and load impedances generally give different incident powers.

Power gain G is the ratio of net power delivered to the load to net power delivered to the input of the DUT. G depends on the load impedance connected to the DUT but not on the source impedance. Expressions for G contain Z_L or Γ_L but not Z_s or Γ_s . Although the numerator and denominator of G each depend on the source impedance, both depend on it in the same way and the effect cancels out. Because power gain is independent of source impedance, it is not very useful for noise characterization. Power gain tends to be more useful for the output sections of systems, where the load is already defined by the application.

Available gain G_a is the ratio of the power available at the output of the DUT to the power available from the source. G_a depends on the source impedance but not on the load impedance. For measuring or calculating the power available at the output of the DUT, the load must be adjusted to be a complex conjugate match of the impedance looking back into the DUT. Thus the load impedance is set by the definition and is not a variable. The power available at the output of the DUT, however, does depend on how much power gets into the DUT. Thus the power available at the output depends on the degree of mismatch between the source and the input of the DUT and consequently on the source impedance. For the denominator, however, finding the power available from the generator requires that the generator's load be adjusted to be the complex conjugate of the source impedance. That power is entirely independent of the DUT characteristics. The available noise power from a source is often the well-known kTB of thermal noise. This makes available gain useful in noise characterization.

Available gain is also very useful when units are being cascaded. G_a of the cascaded combination is the product of individual available gains. This is because the numerator of G_a for one stage (power available at the output) is the same as the denominator of G_a for the succeeding stage (power available from the source). The available gain for each stage must be for a source impedance that corresponds to the output impedance of the preceding stage.

Transducer gain G_t is the ratio of power delivered to the load to the power available from the source. An optimally designed, passive, lossless matching network theoretically delivers the power available from the generator to the load and therefore has a transducer gain of 1 (or 0 dB). The transducer gain therefore tells how much more power the transducer (DUT) delivers to the load than the theoretical optimum, passive, lossless matching network. Transducer gain is a function of both the load impedance and source

impedance. Each value of transducer gain applies only to a specific load impedance and a specific source impedance. Transducer gain has the disadvantage that it is not convenient when cascading.

Insertion gain G_i is the gain that is almost always measured. The numerator consists of the power delivered to the load by the DUT and the denominator is the power delivered without the DUT, i.e., directly from the generator to the load. If the DUT performs frequency translation, e.g., a receiver or mixer, the generator for the numerator is at a different frequency than the generator for the denominator.

Which gain is being measured and which gain is desired is often critical in noise figure measurement situations. Casual observation may lead one to think he is measuring the forward transmission coefficient $|S_{21}|^2$ when he is actually measuring insertion gain. For amplifiers or other non-frequency translating devices, the ratio of the gains is

$$\begin{aligned} \Delta |S_{21}|^2 \text{ (dB)} &= |S_{21}|^2 \text{ (dB)} - G_i \text{ (dB)} \\ &= 10 \log \frac{|S_{21}|^2}{G_i} \\ &= 10 \log \frac{|1 - \Gamma_s S_{11}|^2 |1 - \Gamma_1 \Gamma_2|^2}{|1 - \Gamma_1 \Gamma_2|^2} \quad (1-4) \end{aligned}$$

where Γ_1 refers to measurement system input, Γ_s refers to the source used for measurement, S_{11} refers to the DUT, and Γ_2 refers to the reflection coefficient looking back into the output of the DUT while the source is connected to the input. For a source SWR of 1.25, a system (load) SWR of 2.0, a DUT input SWR of 1.2, and a DUT output SWR of 2.0, the worst case uncertainty in $|S_{21}|^2$ is +1.3 dB and -1.5 dB. The RSS uncertainty is 1.1 dB.

Even though insertion gain is usually measured, it would be most desirable to measure available gain. Available gain, however, requires power measurements at two points, and each measurement requires adjusting or tuning the load impedance to be a conjugate match to the port being measured. For simplicity, therefore, insertion gain is usually measured and assumed to be equal to available gain. The error in this assumption when measuring amplifiers is

$$\begin{aligned} \Delta G_a \text{ (dB)} &= G_a \text{ (dB)} - G_i \text{ (dB)} \\ &= 10 \log \frac{G_a}{G_i} \\ &= 10 \log \frac{(1 - |\Gamma_s|^2) |1 - \Gamma_1 \Gamma_2|^2}{(1 - |\Gamma_2|^2) |1 - \Gamma_1 \Gamma_s|^2} \quad (1-5) \end{aligned}$$

For a source SWR of 1.25, a system (load) SWR of 2.0, and a DUT output SWR of 2.0, the worst case uncertainty in available gain is +1.1 dB and -0.2 dB. This analysis shows that the available gain is usually larger than the insertion gain.

Measurement of Noise Figure and T_e

Noise figure and effective input noise temperature are usually determined by measuring two points along the straight-line noise characteristic. Figure 1-7 shows those two points corresponding to two noise source temperature the input — one hot (T_h) and one cold (T_c). Although many different types of noise sources are used, most measurements use an avalanching semiconductor diode for T_h with an effective temperature of about 10000K. For T_c the bias is removed from the diode so that avalanching ceases and the effective temperature corresponds to the physical temperature of the source. Manufacturers of noise sources usually specify the excess noise ratio (ENR) instead of T_h . The relationship between the two terms is

$$\text{ENR} = 10 \log \frac{T_h - T_o}{T_o} \quad (1-6)$$

Sometimes T_{on} and T_{off} are used instead of T_h and T_c . The noise powers at the output of the DUT are often labeled N_2 (corresponding to T_h) and N_1 (corresponding to T_c). The ratio N_2/N_1 , is called the Y factor.

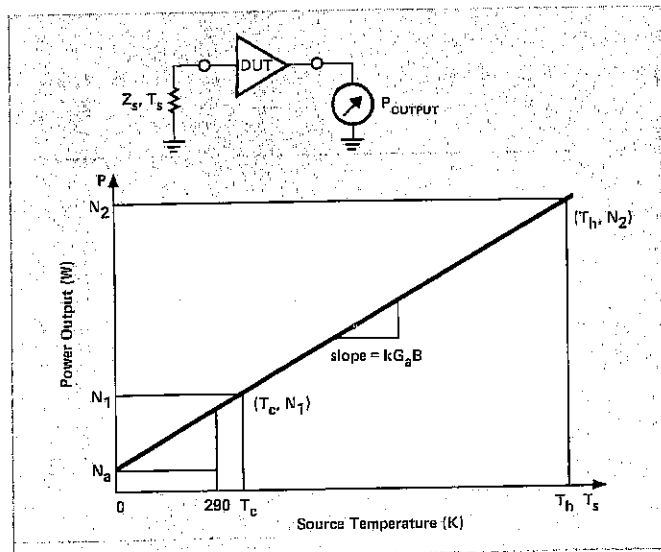

Figure 1-7. The straight-line noise characteristic is usually determined by measuring two points along the straight line.

Once the two points along the straight line are determined, ordinary algebra can be used to find noise figure F , effective input noise temperature T_e , and the gain-bandwidth product. The HP 8970A Noise Figure Meter performs the algebra with a microprocessor. The results are

$$T_e = \frac{T_h - Y T_c}{Y - 1} \quad (1-7)$$

$$F = 10 \log \frac{T_e + T_c}{T_c} \quad (1-8)$$

$$kGB = \frac{N_2 - N_1}{T_h - T_c} \quad (1-9)$$

Older style noise figure meters, without a microprocessor, display results that are restricted in several ways. Most of them don't display T_e , for example, and they only allow certain values of T_h and T_c .

In summary, the noise quality factors of a linear two port are easy to interpret from the straight-line noise characteristic. In most practical situations, the bandwidth and the frequency of measurement are determined by the noise measurement equipment. As the noise figure or effective input noise temperature increases, but with gain remaining constant, the straight line translates upward. A noise-free amplifier ($T_e=0K$ and $F=0$ dB) has a characteristic that goes through the origin.

If the gain changes, but the noise figure and T_e remain constant, the slope of the straight line changes but the X-axis intercept at $X = -T_e$ remains fixed.

Some Typical Noise Figures

When people begin to consider noise figure measurements, they wonder if their application is typical or if it is at the state-of-the-art. This section discusses typical and state-of-the-art performance in the early 1980's. The numbers are approximate and should not be considered as absolute. They should not be used as specifications.

The state-of-the-art in transistors is shown in Figure 1-8. The very low noise figures on that graph are achieved by cooling the devices with liquid helium, that is, cryogenic cooling. Well-designed, low-noise amplifiers for a specific communication band using those transistors would likely have a noise figure from 0.2 to 0.5 dB larger than the transistor noise figure due to network losses and the inability of creating an optimum noise environment at all frequencies.

Non-cooled, low-noise amplifiers for satellite reception in the 3.7 to 4.2 GHz band have noise figures on the order of 1.0 to 1.6 dB (T_e from 75 to 130K). A non-cooled, low-noise

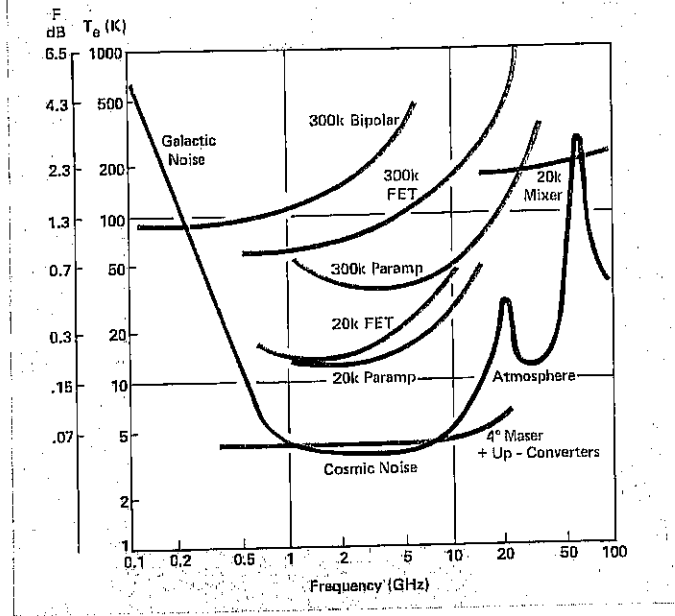

Figure 1-8. The state-of-the-art noise figure and effective input noise temperature in transistors. From Sander Weinreb, *LOW-NOISE COOLED GASFET AMPLIFIERS*, ©1980, *IEEE Trans. on Microwave Theory and Techniques*, Vol. 28, No. 10, Oct., 1980, p. 1041. Some recent advertisements for 300K FET's have shown T_e 's that are about 50K lower than shown here.

amplifier designed for the broad 6 to 18 GHz band can have a noise figure on the order of 7 dB across that entire band. At lower frequencies, lower noise figures are possible. At 144 MHz, radio amateurs have been using non-cooled amplifiers with noise figures down to 0.3 dB ($T_e=21K$).

Before discussing mixer noise figures, it is necessary to discuss single sideband (SSB) and double sideband (DSB). An ordinary mixer, in combination with its local oscillator and IF amplifier, accepts input signals and noise from two frequency bands (DSB) corresponding to $(f_{LO}+f_{IF})$ and $(f_{LO}-f_{IF})$. Communication systems, however, normally have useful signal in only one of those bands. The other band or other response is often referred to as the image band or image response. According to the rigorous definition of noise figure (see glossary), the DSB mixer's noise figure is the wrong one to predict S/N degradation in a system where signal comes in only one sideband (SSB). The image response is a spurious response. The noise of the image response tends to obscure weak signals in the desired sideband and the noise figure should reflect this less-than-perfect performance. But the noise figure measurement system normally has no way of knowing that the extra response is not a desired response. A correction must

be applied after the measurement. The measured DSB noise figure should be increased by 3 dB for direct use in SSB applications (assuming equal GB for the signal band and image band). A convenient method of remembering the correction is to "penalize" the system for too great a bandwidth, e.g., the measured noise figure is 3 dB low when measured DSB but used SSB. The 8970A Noise Figure can make the correction.

If the gain or conversion loss of a DSB (or image responding) mixer or receiver is measured by using the slope of the straight line in **Figure 1-4**, the measured gain will also be in error. The slope measurement actually characterizes the gain-bandwidth product (GB). For a DSB mixer or receiver, the indicated gain is actually about 3 dB too large because the mixer input bandwidth is twice as large as the bandwidth at the input to the measurement system. The operator can direct the microprocessor in the HP 8970A Noise Figure Meter to correct the output readings for such effects.

If a mixer includes a preselecting filter, or has built-in image rejection, so that input noise from the undesired sideband is not processed, the measured noise figure (SSB) and gain require no correction.

There are occasions, however, when the information in both sidebands is desired and processed. Then the measured DSB noise figure is proper and no correction should be performed. In many of those applications, the signal being measured is radiation so the receiver is called a radiometer. Radiometers are very common in radio astronomy.

Mixers form part of the down-converter used to measure microwave amplifiers. The down-converter is part of the measurement system, converting the microwave output frequencies of the DUT amplifier to a convenient frequency range for noise measurement. When making such measurements, it normally makes little difference whether the measurement system is SSB or DSB — providing the noise figure and gain of the DUT are constant across the frequency range of measurement. For a DSB down-converter, information in both sidebands is desired and processed. No 3 dB correction should be made. A SSB measurement for the amplifier should give the same result. But because the DSB measurement consists of average power readings in the upper and lower sidebands, the DSB result could be in error because of fine-grain variations with frequency. In other words, the DSB result might be in error only because it is measuring in two windows and the result is an average in those windows.

Noise figure measurements of mixers may be confusing and deserve some special discussion. DSB mixer noise figures can be about 3 dB although 5 to 9 dB seems more typical of general purpose devices. A mixer with a filter on

its input to remove noise in the undesired sideband would yield a combined noise figure that is about 3 dB higher plus the loss of the filter. The noise figure and conversion loss of an SSB mixer are usually quite close but can be about 1 dB apart in either direction. The local oscillator drive power needed for lowest noise figure is usually smaller than that needed for lowest conversion loss. The higher drive power associated with the lowest conversion loss leads to somewhat higher shot noise.

IF amplifiers that follow mixers are often integrated with the mixer to control mismatch effects. Off-the-shelf IF amplifier noise figures of 1.5 dB are common. IF amplifiers with 0.2 dB noise figure are possible.

Combining noise figures of several components connected together is discussed in the glossary under "Cascade Effect". The noise figure of most communication systems is roughly equal to the noise figure of the first amplifier in the system added to any loss between the antenna and the amplifier. Consider the example of a receiving antenna connected through a cable with 0.5 dB loss to the input of a mixer that has an 8 dB noise figure and 8 dB conversion loss. If the IF amplifier has 1.5 dB noise figure, the overall receiver noise figure would be about 10 dB. By merely adding a small-size, high-gain, 1.2 dB noise figure preamplifier at the antenna (so cable loss comes after the amplifier), the receiver noise figure is reduced to about 1.2 dB. The noise added by the components of the original 10 dB system gets divided by the gain of the preamplifier of the new system.

The ability to economically reduce system noise figures with preamplifiers has stimulated the need for accurate noise figure measurements at every level of use. This includes measurements of transistors, amplifiers and receiving systems. Such measurements are usually needed in most functional areas — research and development, production, quality assurance, and maintenance.

2. The Measurement of Noise Characteristics

The purpose of this chapter is to discuss the methods of measuring noise figure, both old and new, and the measurement equipment. Noise figure meters will receive the most attention. Many microwave components require noise characterization as a function of frequency. Much discussion will occur about down converters to translate the frequency of the noise power output from the DUT to the input frequency range of the noise figure meter.

The description of the various measurement techniques in this chapter will often refer to the straight-line noise characteristic discussed in the first chapter. The signal generator method, to be discussed at the end of the chapter, basically measures the slope of the straight line (or the gain-bandwidth product) and then one point along the line. From that slope and the one point, the noise figure can be calculated. The other methods of measuring the noise characteristics depend on measuring two points along the straight line. The two points correspond to two different source temperatures that are referred to as T_h and T_c .

Noise Sources

The measurement of two points along the straight line requires two different temperatures for the source impedance at the input of the DUT. The devices used to achieve the effect of two source temperatures include temperature-limited vacuum diodes (also called thermionic diodes), gas-discharge tubes, and avalanche diodes, as well as physically heated and cooled terminations. Most noise sources, but not heated and cooled terminations, are specified by their Excess Noise Ratio (see glossary). Each kind of noise source will now be discussed.

In the 1950's noise sources whose characteristics could be theoretically derived were the most popular. Calibration techniques for measuring noise sources were not very well developed. Vacuum diodes depend on shot noise generated by the quantized and random flow of electrons going from the cathode to the plate when the vacuum diode is operated in the temperature-limited region. The fluctuating plate current from the diode passes through a resistor and thus generates a fluctuating voltage drop. From the temperature-limited current and the resistance, the noise power output can be determined theoretically. The noise power output can also be varied by varying the diode current. By the end of the 1970's, noise source calibration techniques had been developed and the vacuum diode lost favor to the avalanche-diode noise source. The vacuum diode has a limited frequency range because of the cathode to plate transit time. For this reason vacuum diodes were used mainly in the IF and VHF ranges. Even in the VHF range correction factors were usually needed for transit-time effects. The vacuum-diode noise source, furthermore, re-

quires a high-voltage power supply not common in modern, solid-state instruments and systems.

The gas-discharge tube noise source [22] has been popular in upper VHF, microwave, and millimeter frequency ranges. Noise is usually coupled from the electron stream into rectangular waveguide by placing the gas-discharge tube across the waveguide at a slight angle. It is coupled to coax line by means of a helix. Gas-discharge tubes require a power supply of several thousand volts to initiate ionization of the gas. Once ionized, however, only 100 to 300 volts are needed to sustain the discharge at the best current (50 to 200 mA). Gas-discharge noise source tubes come in two varieties — those with cold cathodes and those with hot cathodes. Noise figure meters that use gas-discharge tubes usually use cold-cathode tubes. Those meters depend upon turning the gas-discharge noise tube on and off at a 500 to 1000 Hz rate. Hot-cathode tubes, when turned on and off at such rapid rates, were short lived because at turn on, the ions in the gas discharge bombarded the cathode. Bombardment deteriorates the cathode. When the United States National Bureau of Standards (NBS) tried to calibrate a cold-cathode gas-discharge tube, they found that the noise power output was unstable. The initial gas-discharge breakdown spike would have long ringing effects on the noise power output. It was difficult for the people at NBS to know when to begin the measurement of power output. Such instabilities have not been noticed in recent years at Hewlett-Packard. A cold-cathode tube, for example, has been compared to a hot-cathode tube and there has been no noticeable change in the noise power generated over more than 10 years. The gas-discharge tube is being replaced by the avalanche solid-state diode noise source wherever possible because of a broader frequency range and simpler power supply requirements. The avalanche diode can cover many waveguide bands. The power supply for gas-discharge tubes is a serious problem because the several-thousand volt spike needed for turn-on can feed through into the signal output port and damage sensitive, high-frequency transistors in the devices that are being tested.

The avalanche solid-state diode noise source depends upon noise generated by the spontaneous generation of charge in the avalanche region. For many years, the avalanche diode noise source suffered from poor stability with time. The poor stability has been largely alleviated by the use of guard rings, good heat sink design, and constant current drive [4]. The guard rings and heat sink assure a uniform and repeatable breakdown potential and current. The Hewlett-Packard 346B Noise Source has such improvements. The advantages of the avalanche diode noise source include small size, light weight, and low power requirements. They can also be broadband — the HP 346B, for example, covers 10 MHz to 18 GHz and has a very low reflection coefficient.

Physically heated and cooled terminations are used as noise sources in calibration laboratory applications. These noise sources serve as fundamental physical standards. The cold noise source usually consists of a termination that is placed in liquid nitrogen and thus has a temperature of about 77K. The hot noise source is usually a termination kept in an oven that is regulated to 373K. The measurement technique with a hot/cold noise source is very tedious. Measurement with such noise sources is usually reserved for calibrating other noise sources by highly-skilled, calibration laboratory personnel. Measurement with hot/cold sources will be discussed later.

The calibration of noise sources is based on two kinds of standards. The first kind includes transfer standard noise sources measured by NBS. The second kind depends on comparison to a primary physical standard, that is, a hot/cold load. NBS calibration of noise sources is only available at certain frequencies. These presently include 30 and 60 MHz, 2.65 to 3.95 GHz, 8.2 to 18 GHz, and some millimeter waveguide bands. At other frequencies calibration must be done without reference to NBS by comparison of the DUT noise source to a hot/cold termination operated at known temperature.

Noise Figure Meters

Noise figure meters became popular in the late 1950's. Then, as now, noise figure meters operated by turning a noise source on and off and measuring the corresponding power outputs from the device under test (DUT), N_2 and N_1 . There are two different kinds of noise figure meters. The first is the traditional type that was initiated in the late 1950's and gradually improved over the years. The second type is more modern and takes advantage of the available microprocessor technology to increase accuracy and convenience. Each type will be considered.

The traditional noise figure meter is an analog instrument that displays noise figure on a meter. The noise figure is usually found by using automatic gain control circuits, a non-linear meter scale, and several power measuring detectors. These instruments all assume that the cold temperature of the noise source is equal to the standard temperature of 290K. The traditional instruments use only one value of excess noise ratio (ENR), that is, T_h . The input frequency range is normally limited to one or perhaps a few frequencies. Many of the traditional noise figure meters have low sensitivity and can only measure devices with a gain of about 30 dB or higher. These noise figure meters, furthermore, indicate the overall noise figure — including not only the DUT but also the noise contribution of the measurement equipment connected to it. The noise contribution of the measurement equipment can be significant and will soon be discussed.

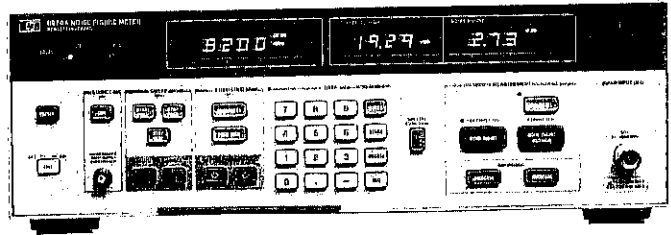

Figure 2-1. The HP 8970A Noise Figure Meter that includes a microprocessor to relieve the many operations involved in data collection and manual error correction that traditionally accompanied accurate noise figure measurements.

The modern noise figure meter, such as the HP 8970A shown in Figure 2-1 [32], can use modern tuning techniques and a microprocessor to overcome many of the disadvantages of traditional noise figure meters. The increased capability reflects the recent needs to measure receivers and components such as preamplifiers, mixers, and transistors. The microprocessor can control measurements and make calculations. The random access memory (RAM), for example, can handle a broad range of values for T_h and T_c . The calculations can account for several effects that were accepted as errors with traditional noise figure meters. The microprocessor also can calculate the slope of the straight-line noise characteristic and hence find the gain of the DUT. The input frequency can be tuned across the VHF/UHF range, which is convenient for SSB measurements and avoiding transmissions that interfere with measurements. By including an internal, low-noise preamplifier, the modern noise figure meter is sensitive enough to measure low-gain and even lossy devices. Three forms of error correction will now be discussed separately, ENR variations with frequency, the cold noise source temperature, and the measurement system noise contribution.

ENR Variations with Frequency

Noise sources usually have an ENR that varies by several tenths of a dB across their frequency range. A table of ENR values may be stored in the noise figure meter's RAM. As noise power measurements are made at various frequencies, the 8970A looks up the ENR data for the noise source at the closest two frequencies and interpolates the proper value for the measurement frequency. It uses that value to calculate the DUT noise figure. Once the operator enters the ENR values for the noise source being used, the corrections are made automatically unless the operator overrides them.

Cold Noise Source Temperature

For most noise figure measurements, the cold source temperature is the physical temperature of the noise

source. Traditional noise figure meters assume the physical temperature is 290K to simplify finding noise figure. The HP 8970A uses a value selected by the operator (the default value is 296.5K) when calculating T_e and F .

Second Stage Noise Contribution

Noise measurement tends to characterize all the noise that is added including that added by the measurement equipment. The measurement equipment includes not only the noise figure meter, but any other equipment added after the DUT, such as a down converter to convert the output frequency from the DUT to the frequency range of the noise figure meter. Let F_1 denote the noise figure of the DUT, G_1 its gain, and F_2 the noise figure of the measurement system, i.e., the second stage. The noise powers that are measured, N_2 and N_1 , include noise added by the DUT and measurement system. The relationship between the overall noise figure F_{12} (expressed as a numerical ratio and not in dB) and the individual parameters (as a ratio) is given by

$$F_{12} = F_1 + \frac{F_2 - 1}{G_1} \quad (2-1)$$

This relation is derived in the Appendix and is discussed in the glossary under Cascade Effect. Note that the measurement system noise figure F_2 is divided by G_1 . For receiver measurement, where G_1 is often 1000 or more, the second term is usually insignificant. For amplifiers or devices where G_1 is on the order of 10 or less, the second term becomes very significant.

Until the HP 8970A Noise Figure Meter, noise figure meters only indicated F_{12} and not F_1 . Finding F_1 required a solution of equation (2-1) by hand calculation. Separate measurements would have to be made of F_2 and F_{12} . Furthermore, G_1 would often have to be measured on a completely separate measurement system. The measured data would then be inserted into equation (2-1) to calculate F_1 . This process was not only very tedious but required skilled personnel.

With the 8970A the operator measures F_2 in a separate step, called calibration, when the 8970A stores the noise characteristics of the system in its memory. Then for later measurements, with the DUT inserted between the noise source and the measurement system, the 8970A measures F_{12} and G_1 , looks up the stored value of F_2 , and uses equation (2-1) to solve for F_1 . The correction is done automatically.

Frequency Converters

Receivers almost always contain frequency conversion to an IF. Noise figure meters are designed to receive the IF

output signals from receivers. Thus noise figure meters tend to work with signals that are already down converted to the IF range. Although the HP 8970A Noise Figure Meter internally performs the necessary frequency conversion for frequencies below 1500 MHz, a down converter is needed for measuring microwave components that do not translate frequency, including preamplifiers and transistors. In this case the down converter becomes a part of the noise figure measurement system. This section will discuss the selection of equipment to construct a down converter that will become a part of the measurement system.

A down-converter consists of a mixer, local oscillator (LO), and sometimes an IF amplifier (Figure 2-2). Each element of the down converter will soon be discussed separately. Of the many frequencies where noise power is available at the input of the down converter, the down converter takes those frequencies that satisfy the equation

$$f_{\text{MEAS}} = f_{\text{LO}} \pm f_{\text{IF}} \quad (2-2)$$

(where f_{LO} is the local oscillator frequency) and converts them to f_{IF} the actual input frequency of the noise figure meter. Measurements where the plus sign of equation (2-2) applies are called upper sideband (USB) measurements because the measurement frequency is above the local oscillator frequency. Measurements where the minus sign of equation (2-2) applies are called lower sideband (LSB) measurements because the measurement frequency is below the local oscillator frequency. When either the upper or lower sideband applies, the system is referred to as single sideband (SSB). The other sideband, usually suppressed by the network design, is often referred to as the "image" response. If both the plus and minus sign apply, the measurement actually consists of two frequency bands that are separated by twice the IF. Such measurements are referred to as double sideband (DSB). Single sideband (SSB) measurements, that is USB or LSB, will be discussed later.

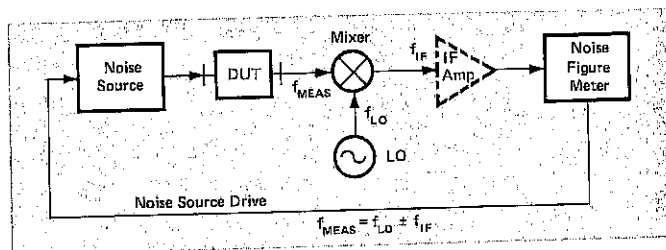

Figure 2-2. The general block diagram of a down converter to be used as part of a noise figure measurement system. The IF amplifier is outlined in dashes because the high sensitivity of the 8970A Noise Figure Meter means the IF amplifier is usually not necessary. The 8970A, because of its tunable input frequency or variable IF, allows swept frequency measurements with a fixed-frequency local oscillator.

Noise contributed by the down-converter is included as part of the second stage noise contribution (F_2 in the previous discussion). The modern 8970A Noise Figure Meter can back out the noise contribution of the second stage, including the down-converter, to give the noise figure and gain of the DUT by itself.

It is very important to have a low-noise contribution from the down converter. Noise and spurious signals added by the down converter can degrade measurements in two ways. One is increased second stage noise figure. The second is the total power at some point in the system may get so high that circuit non-linearities occur (clipping, saturation, gain compression, etc.).

High second stage noise figure, even when corrected by a microprocessor controlled noise figure meter, can be a problem. Rearranging eq (2-1) as

$$F_1 = F_{12} - \frac{F_2 - 1}{G_1} \quad (2-3)$$

shows that the final DUT noise figure is the difference between two numbers. If those two numbers are approximately the same size, small errors or jitter in either number has a large effect on DUT noise figure F_1 . The second term on the right of eq (2-3) can become large either by large F_2 or small G_1 or both. It is therefore important to keep F_2 as small as practical. For the 8970A, the effects of jitter can be reduced at the expense of measurement time using the built-in smoothing function where several measurements are averaged before displaying the final result. The operator can select the 8970A to make 1 to 512 measurements for each result. If 16 or more measurements must be averaged while the DUT is being measured to have jitter in F_1 be less than 0.1 dB, the measurement is probably too sensitive to F_2 and the down converter should be improved if practical.

The second possible problem, high total power causing non-linearities, usually occurs ahead of the filters that determine the measurement bandwidth. Test procedure designers should be aware of the total power at every point in the system. When powers get up to approximately -30 dBm, linearity tests should be made. The broadband power can usually be lowered by filters, attenuation, or reduced gain.

The 8970A solves its own problem by monitoring the total power from 10 to 1500 MHz near its input. It automatically removes some of its gain or adds attenuation to prevent non-linearities. During calibration, the 8970A routinely measures its noise contribution at each frequency for three configurations of its broadband input circuits: 20 dB gain, 10 dB gain (20 dB gain followed by 10 dB attenuation), and 0 dB gain (10 dB attenuation, 20 dB gain, and 10 dB attenuation). It is then ready for higher total power at its input. If the power is so high that the 8970A

still cannot cope, appropriate error messages are displayed instead of an erroneous measurement result.

Increasing attenuation in the 8970A raises second stage noise figure F_2 . This would normally tend to cause large second stage corrections. If the cause of high total power is high G_1 , however, the large G_1 in the denominator of eq (2-3) compensates for the larger F_2 and the total second stage term is hardly changed. There is only a problem when the large power, which results in reduced 8970A gain or increased attenuation, is caused by excessive added noise from the mixer or local oscillator of the down converter.

Mixers

A mixer to be used in a general-purpose down converter to cover many measurement situations, should have the proper frequency range, low conversion loss, low noise figure, low input reflection coefficient, and high noise rejection.

A very important quality of a mixer for general purpose noise measurement is that it reject noise coming from the LO. Balanced and double-balanced mixers are designed to have this quality. Such mixers contain at least two diodes arranged so that down-converted power at the measurement frequency, that entered through the LO port, combines out of phase. Thus there is much smaller IF output due to signal at the LO port of the mixer. Broadband, double-balanced mixers, in the frequency band where they are balanced, have 20 dB or more extra conversion loss for signals that enter through the LO port than for signals that enter through the normal signal port.

Low conversion loss usually corresponds to a low noise figure for the mixer. Mixer noise figure directly affects F_2 , the noise figure of the measurement system (the second stage). As discussed above, a large F_2 could mean that F_1 is found by taking the difference between two numbers of about the same size (the two terms on the right side of equation (2-3)). Such subtractions make the final answer extremely sensitive to small measurement variations and to uncertainty in F_{12} , F_2 , and G_1 . Thus low mixer noise figure and loss are important.

The SWR of a mixer at the signal input port is important because it contributes to re-reflections. The effect of the re-reflections is often called mismatch uncertainty and is discussed in the glossary. Mismatch uncertainty affects the accuracy of the second stage noise characterization and the accuracy of the gain measurement. The input reflection coefficient of the mixer is the load reflection coefficient, Γ_1 for the DUT. The measured gain is actually the insertion gain (see glossary) rather than the available

gain. A ratio of available gain to insertion gain from equations in the glossary is

$$\frac{G_a}{G_i} = \frac{1 - |\Gamma_s|^2}{1 - |\Gamma_2|^2} \cdot \frac{|1 - \Gamma_1 \Gamma_2|^2}{|1 - \Gamma_1 \Gamma_s|^2} \quad (2-4)$$

where Γ_1 is the reflection coefficient looking into the mixer, Γ_s is the noise source reflection coefficient, and Γ_2 is the reflection coefficient looking back into the output port of the DUT with the noise source connected to the input. Eq (2-4) shows that if Γ_1 is zero, G_a and G_i are more nearly equal.

The SWR at the mixer input can usually be improved by placing an attenuator, an isolator, or a circulator at the mixer input. The loss of any of these devices directly raises the noise figure of the second stage. An isolator or circulator is preferred to the attenuator because it has less loss and causes less degradation in the second stage noise figure. An attenuator should be added when more accuracy is to be gained from improved mismatch than is lost due to poorer second-stage noise figure. Using a 3 dB attenuator results in a larger second stage correction but it can cover a broad frequency range. Isolators and circulators are more limited in frequency range.

Local Oscillators

The local oscillator for the system down converter should cover a broad frequency range, have enough power output to properly drive the mixer, and have a low level of noise output in the form of a low broadband noise floor.

Many noise figure measurement systems need to cover a broad frequency range so they can measure a large variety of devices. A broad-range LO that can be electronically tuned is therefore convenient. Using, for example, the HP 8672A Synthesized Signal Generator, covering 2 to 18 GHz, with the HP 8970A Noise Figure Meter allows device measurements from 10 MHz to 18 GHz. The frequency range is covered in three steps. 1) The 8970A Noise Figure Meter covers the 10 to 1500 MHz range by itself; 2) for 1.5 to 2 GHz, the 8672A, operating above 2 GHz, a mixer, and a low-pass filter (like the HP 360C with a 2.2 GHz cutoff frequency) can be used to make lower sideband measurements as described in HP Product Note 8970A-1 and 3) for 2 to 18 GHz, the 8672A and a mixer form a down converter to be used with the 8970A.

Most double-balanced mixers require an LO drive of about 7 dBm for lowest mixer noise figure. A slightly smaller power output, like 5 dBm, degrades the noise figure, but usually not enough to be important if second stage correction is used. The HP 8672A-Option 008 is guaranteed to have at least 8 dBm output across the band and would thus be ideal for driving mixers. Yet using standard

8672A's, with at least 3 dBm output, usually works very satisfactorily. Certain advanced mixers, such as some designed for an especially good match or designed to reject the image frequencies, contain eight or more diodes and can require LO drive powers of about 20 dBm. Still other mixers are biasable with DC and require LO drive powers of only about 0 dBm.

The noise level, including spurious output, that emerges from the LO is important because the noise can be down converted to the IF range and cause either or both of the problems mentioned earlier — high second stage noise figure or high total power that could lead to non-linearities. Reducing the high total power with attenuators could lead to high second stage noise figure. The noise is added at the mixer and can cause a very large second stage noise figure. This note will now discuss some properties of oscillators, then some noise rejection properties of mixers, and then the performance of certain types of LO sources.

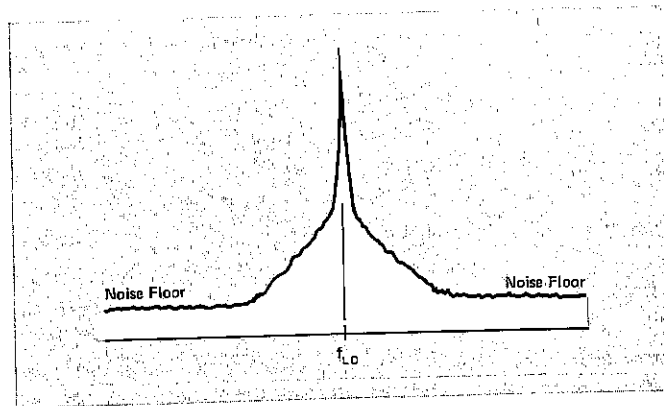

Figure 2-3. The power spectrum of a typical microwave oscillator. At frequencies close to f_{LO} , the desired output frequency, the noise power output is determined by the noise properties of modulating circuitry and the Q of the oscillator. Modulating circuitry includes frequency control loops and level control loops. At frequencies further removed from f_{LO} , modulation effects decrease and the resonant circuit in the oscillator filters noise from the active oscillating device. At tens of megahertz from f_{LO} , the noise power declines to the broadband noise floor. The noise floor is often determined by thermal noise and subsequent power amplifier noise contributions.

The frequency bands of importance are the measurement bands — frequencies spaced from the LO frequency by the IF frequency. The power spectrum of a typical oscillator is sketched in Figure 2-3. Besides the operating frequency, f_{LO} , there is noise power output at other frequencies. The noise power per hertz of bandwidth falls off as the frequency becomes further removed from f_{LO} . The rate of fall-off depends on parameters like oscillator Q, and

the gain and noise characteristics of frequency and level control loops. At frequencies tens of MHz away from f_{LO} , the gain and added noise of oscillator circuitry and of control loops has likely fallen to levels close to thermal noise. This means the broadband noise floor of many oscillators will only be slightly larger than the limit

$$N_{LO \min} = -174 \text{ dBm/Hz} + G(\text{dB}) + F(\text{dB}) \quad (2-5)$$

where G and F refer to the gain and noise figure of amplifiers that follow the oscillator.

Balanced and double-balanced mixers have more than one diode to perform the frequency conversion. The circuitry for the diodes is specially arranged so that the converted LO noise from one diode is in the opposite polarity than for another diode. The result is that LO noise is rejected — at least to the extent of proper circuitry and similarity of the diodes. LO noise rejection is not a specification of most mixers, but LO to IF isolation is frequently specified. LO to IF isolation does not refer to frequency conversion of signals in the LO port — only to actual signal feedthrough from the LO to the IF port. Still LO to IF isolation is usually a good indicator of LO noise rejection. Broadband mixers typically have at least 20 dB rejection of LO noise although 30 or 40 dB is not uncommon — especially near the center frequency of design for the mixer.

Certain kinds of LO sources tend to work well in noise figure systems and other kinds do not. The ultimate test as to whether an oscillator/mixer combination is suitable or not is to try the system to see if the noise figure is satisfactory (using the jitter test explained near eq (2-3)). Cavity oscillators and others with high-Q resonant circuits are usually OK. An oscillator followed by a broadband, high-gain amplifier will have a high noise floor. For this reason, signals generated by down converting a higher frequency and then amplifying (sometimes called heterodyning) are usually not satisfactory unless conditioned. This type of oscillator includes many of the microwave oscillators that have extended coverage below 2 GHz. One conditioning method is to follow the oscillator with narrow-band tracking filter, such as a YIG filter. The broadband noise floor is filtered and the oscillator will usually be satisfactory. Another method of conditioning is to place a bandpass filter (with, for example, a 10 MHz bandwidth) at the mixer output to allow the desired IF to pass but to filter the broadband noise floor. Lowering the noise floor with filters reduces the need for preventing non-linearities with an attenuator.

IF Amplifiers

Systems which use a high-sensitivity noise figure meter like the HP 8970A do not normally require an IF amplifier. Other noise figure meters often specify a minimum net

external gain (usually about 30 dB) for proper measurements. An IF amplifier of 30 dB or more gain is often used for this purpose. The bandwidth of the IF amplifier should be larger than the bandwidth of the noise figure meter to minimize the effect of noise contributions from the noise figure meter. If the IF gain is too large, more than about 70 dB, there is danger of saturating or clipping on noise peaks, resulting in added measurement errors. Clipping and saturation can occur in later stages of the IF amplifier or in the noise figure meter.

Y-Factor Measurement

Y factor refers to the ratio of noise power outputs (N_2/N_1) corresponding to the two source temperatures T_h and T_c . In traditional noise figure measurements, the Y factor was the raw experimental data. This was the measurement result that was taken before T_h and T_c were included in calculations and before corrections were made for second stage noise contribution. From the Y factor, noise figure can be calculated according to

$$F = \frac{\left(\frac{T_h}{290} - 1\right) - Y \left(\frac{T_c}{290} - 1\right)}{Y - 1} \quad (2-6)$$

Y factor technically refers to the ratio N_2/N_1 as discussed above. But many metrologists also consider that Y-factor measurement implies that the measurement setup is that depicted in **Figure 2-4**. The more general technique for measuring power ratios or attenuation with that kind of equipment is often referred to as "IF substitution." That term describes the condition that IF attenuation is increased or decreased with a precision attenuator to compensate for increasing or decreasing power at the RF port of the system to keep the power to the detector constant. The first step of the measurement procedure is to connect the cold source and to set a convenient level of detector output by adjusting the precision attenuator. Then the hot

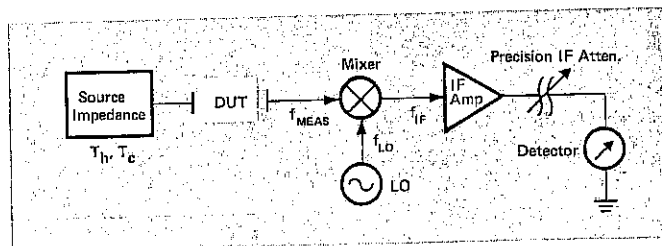

Figure 2-4. The Y-factor measurement technique often refers to using a precision attenuator to substitute for the increase or decrease in the power at the output of the DUT. The change in attenuation necessary to keep the detector at the same output level for T_h and T_c is the Y factor.

noise source is connected to the input of the DUT and the precision attenuator is varied to bring the detector output to the same reading. The change in the precision attenuator is equal to the Y factor.

The advantage of the measurement set up shown in **Figure 2-4** is that the detector operates at the same level for both T_h and T_c , thus avoiding detector linearity errors. The accuracy of measuring the Y factor depends on the accuracy of the precision attenuator. Piston attenuators, using waveguide beyond cutoff, can be very accurate. A commercially available 30 MHz attenuator intended for noise figure work has a specified uncertainty of 0.03 dB + 0.005 dB/10 dB increment. Other causes of instrumentation uncertainty (gain instability, non-linearities, detector resolution, etc.) must be combined with the attenuator uncertainty. As a comparison, the total worst-case instrumentation uncertainty of the modern HP 8970A Noise Figure Meter is ± 0.1 dB. In either case, this error is usually smaller than other causes of uncertainty, especially mismatch effects. In the 1950's, noise figure meter instrumentation uncertainty was approximately ± 1 dB — a dominant source of error. It was during that era that the Y-factor technique with a precision attenuator offered a distinct advantage.

Although the instrumentation uncertainty is often smaller for the Y-factor technique than for the modern noise figure meter, other causes of measurement uncertainty usually dominate noise figure measurements. The Y-factor technique does nothing to reduce those uncertainties and even has an additional potential uncertainty that will soon be discussed. The usual uncertainties include the accuracy of knowing T_h and T_c in equation (2-6), mismatch uncertainty between the noise source and the DUT, and the second-stage noise contribution (although the second-stage effect can be removed by further measurement and calculation with the Y-factor technique).

A variation on the Y-factor technique is the "twice power" method. It uses a 3 dB attenuator at the IF and a calibrated RF attenuator on the noise source to vary the ENR. The procedure is to first establish a reference level at the detector without the 3 dB attenuator and with the noise source turned off. Thus N_1 is established. Then the 3 dB IF attenuator is inserted so the detector reference now corresponds to $2N_1$. The noise source is turned on and the ENR is adjusted until the detector reads the reference level. At this point, the ENR of the noise source/attenuator combination is the same as the DUT noise figure (assuming $T_c = 290$ K). This corresponds to $Y = 2$ and $T_c = 290$ K in eq (2-6) so that $F = ENR$.

The major disadvantage of the Y-factor technique of **Figure 2-4** is the extensive effort in time and energy needed

to make a measurement. The minimum time to collect the data is on the order of one minute per frequency — too long for adjusting noise figure in real time. Such long times have an additional potential problem. The gain of the measurement equipment and DUT must be stable during the entire time. A 0.2 dB change in gain will cause a 0.2 dB change in the Y-factor. Such gain changes might be the result of ambient temperature variations or of power supply variations. The calculations involved to find an accurate value of noise figure demand highly skilled people, even if graphical aids are used.

A modern noise figure meter with fast detection capability, and the ability to change rapidly from T_h to T_c , is replacing the Y-factor technique in most applications. By including the noise figure meter's ability to correct for the second-stage noise contribution, and T_h and T_c variations, the accuracy balance often favors the noise figure meter. Measurements in real time, and the real-time solution of equation (2-6) greatly enhance convenience and add to the popularity of the microprocessor based noise figure meter.

Hot/Cold Measurement

Noise figure measurements using a noise figure meter or the Y-factor technique are actually hot/cold measurements. The term "hot/cold" reflects that two known source temperatures, T_h and T_c , are used at the input of the DUT. Among metrologists, however, hot/cold measurements commonly refer to using a physically hot termination for T_h and a physically cold termination for T_c . The hot termination is usually in an oven at 373K. The cold termination is usually immersed in liquid nitrogen, resulting in a temperature of about 77K. In this section "hot/cold" will mean such physically hot and cold terminations.

Because hot/cold measurements require connecting first one termination, then the other for each measurement, measurements take a long time. Automation with a switch is usually not practical because of errors introduced by the additional losses and reflections of the switch. Furthermore, the Y-factor technique of **Figure 2-4** would be used along with equation (2-6) to calculate noise figure. The 8970A Noise Figure Meter, however, saves much of the tedium by already being programmed to solve equation (2-6) using proper hot and cold source temperatures. When the 8970A is used with an external computer, the noise power measurements can be made at many frequencies for T_h , then at many frequencies for T_c , transferring each measurement to the computer. When all the data is taken, the computer calculates the noise figure and gain of the DUT. This saves connecting each termination at each measurement frequency.

Hot/cold measurements require great skill for accurate results. To show the need for skill, refer again to the

straight-line characteristic of **Figure 1-7**. When a straight line is determined by measuring two points that are very close together, the parameters of the line, noise figure or T_e and gain, are very sensitive to small errors in the coordinates of the two points. Errors might be caused, for example, by jitter, non-linearities, and gain or power supply drift. For the hot/cold method, the abscissas of the points are about 80K and 373K — much closer than the $\approx 295\text{K}$ and $\approx 10000\text{K}$ of usual noise figure measurements.

Hot/cold measurements are saved for the most critical situations because of the skill and large amount of time needed to achieve accurate results. The goal of hot/cold measurements is usually to save at least one echelon in the traceability calibration path of noise sources. Manufacturers of noise sources must often use hot/cold measurements to calibrate the excess noise ratio of their noise sources because NBS offers no noise source calibration service at many frequencies. The hot/cold method is used to relate noise measurements to a fundamental physical standard.

Certain hot/cold measurements are subject to extra sources of measurement error. Some cold terminations are not designed to avoid condensation so that condensation forms and then freezes in the termination or the connecting transmission line. The presence of ice affects propagation and loss and therefore the noise figure measurement accuracy. Another source of error is the temperature gradient along the transmission line from the cold termination to the DUT. The temperature gradient affects the loss of the line and the measurement accuracy. Still another source of error might be heating and cooling of the DUT by the terminations.

Signal Generator Method

In the 1930's and 1940's, when noise figure was first being measured, there were no calibrated noise sources available. The only convenient noise source was a termination at room temperature. The signal-generator method of measuring noise figure was used because it did not need a hot and cold noise source. This method requires using a signal generator to measure the gain vs. frequency characteristic of the DUT or of the DUT and the band-limiting filter. The gain vs. frequency curve is then integrated, usually by graphical methods, to find the gain-bandwidth product of the DUT. Up to this point, the measurement procedure is equivalent to finding the slope of the straight-line noise characteristic discussed in the previous chapter. The signal generator is then removed from the DUT and a room temperature termination is placed at the input. The output noise power, N_o is measured with a power meter or suitable substitute. Thus the coordinates of one point (T_{amb}, N_o) of the straight line noise characteristic are

known along with the slope. If the ambient temperature is assumed to be the standard temperature of 290K, noise figure is given by

$$F = \frac{N_o}{kGBT_o} \quad (2-7)$$

where k is Boltzmann's constant and GB is the above measured gain-bandwidth product.

There are several problems with the signal generator method. Measuring the gain-bandwidth product is a tedious, time-consuming process. Measurement time is too long to make tuning adjustments that minimize noise figure of the DUT. The accuracy of measuring the gain-bandwidth product and N_o is about ± 1 dB at best. This gives a 1 dB uncertainty in the noise figure — large compared to modern noise figure meter methods.

The signal generator method has one advantage that sometimes applies when measuring very large noise figures (greater than about 30 dB). Noise figure meters have a problem measuring very large noise figures because the N_2 and N_1 noise powers measured for T_h and for T_c are almost identical. Ordinary jitter effects can, for example, sometimes cause N_1 to be larger than N_2 , making noise figure calculations meaningless. The noise power output is almost totally due to noise added and hardly at all due to the input noise for either T_h or T_c . Thus the Y factor (and N_2/N_1 in the straight-line characteristic) is very nearly one. The denominator of equation (2-6), $(Y-1)$, becomes very small and is the difference between two numbers of the same size. The result is poor measurement accuracy. The signal-generator method, on the other hand, does not suffer from such a degraded accuracy at large noise figures. The gain-bandwidth product and a single value of power out can be measured to the same accuracy for large noise figures as for small noise figures.

This chapter has briefly discussed the traditional and modern methods of measurement. Other methods of measuring noise figure are variations on one of the above methods. A description of several of these variations is contained in NBS Monograph 142 [24]. In the early days of noise figure, noise source calibration was poor. The popular noise sources used a physical temperature or sources whose output was known theoretically. The once popular signal generator method uses only one source, the ambient temperature. More modern requirements demand more accurate measurements, often by semi-skilled people, to be performed on many devices at many frequencies. Thus the modern trend has been toward equipment with built-in accuracy, that is convenient to operate and does not require a lot of theoretical knowledge and mathematical manipulation. There is often at least one person, however,

in each organization that measures noise figure, who must be aware of the myriad of terms, error corrections, and derivations that have taken place over the years. The

background material is often difficult to find. The following appendix and glossary were written to simplify the task. References are given at the end of the glossary.

3. Appendix

Noise Relations

Relation I.

$$F = \frac{(S/N)_i}{(S/N)_o} \Big|_{T_s=T_0} \quad (3-1)$$

yields

$$F = \frac{N_a + kT_0BG_a}{kT_0BG_a} \quad (3-2)$$

Eq (3-1) is more precisely written as

$$F = \frac{S_i/N_i}{S_o/N_o} \Big|_{T_s=T_0} \quad (3-3)$$

S_i and S_o refer to the signal power available from the source and the DUT output, and N_i and N_o refer to the noise power available from the source and the DUT output. From the definition of available gain

$$S_o = S_i G_a \quad (3-4)$$

The noise power available at the output is composed of two uncorrelated components, amplified input noise and noise added by the DUT. Thus

$$N_o = N_a + N_i G_a \Big|_{T_s=T_0} \quad (3-5)$$

Substitution of eq (3-4) and (3-5) in (3-3) gives

$$F = \frac{S_i}{G_a S_i} \cdot \frac{N_a + G_a N_i}{N_i} \Big|_{T_s=T_0} \quad (3-6)$$

The input noise power that gets amplified is over the noise bandwidth B (the bandwidth of either the DUT or the power measuring equipment, whichever is narrower) so that

$$N_i \Big|_{T_s=T_0} = kT_0B \quad (3-7)$$

Substituting eq (3-7) into (3-6) gives

$$F = \frac{N_a + kT_0BG_a}{kT_0BG_a} \quad \text{Q.E.D.}$$

Relation II.

$$T_e = \frac{N_a}{kG_aB} \quad (3-8)$$

Figure 1-5, repeated here, shows that the slope of the general noise characteristic of a two-port device and the slope of the noise characteristic for a noise-free device are both equal to kG_aB . But the slope of the noise-free characteristic, i.e., the rise/run, is also equal to N_a/T_e . The two expressions for slope must be the same so that

$$kG_aB = \frac{N_a}{T_e} \quad (3-9)$$

This is obviously the same as eq (3-8), Q.E.D.

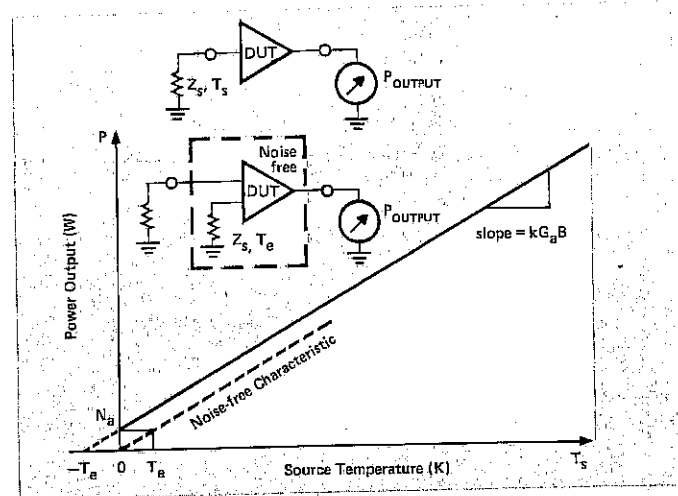

Figure 1-5. Effective input noise temperature T_e shows how hot the source impedance driving a perfect (noise-free) device would have to be to contribute the same noise as the added noise of the DUT. It also turns out that $-T_e$ is the X-axis intercept of the straight-line noise characteristic.

Relation III.

$$F = \frac{T_e + T_0}{T_0} \quad (3-10)$$

Eq (3-9) can be rearranged to give

$$N_a = T_e kG_aB \quad (3-11)$$

Substituting this into eq (3-2) gives

$$F = \frac{T_e kG_aB + kT_0G_aB}{kT_0G_aB} \quad (3-12)$$

or

$$F = \frac{T_e + T_0}{T_0} \quad \text{Q.E.D.}$$

Relation IV.

$$T_e = \frac{T_h - YT_c}{Y - 1} \quad (3-13)$$

where

$$Y = \frac{N_2}{N_1} \quad (3-14)$$

The noise power available at the output of the DUT is composed of two parts, amplified input noise and noise added by the DUT. The amplified input noise available at the output is the product of available gain and noise power available at the input. Thus

$$Y = \frac{N_2}{N_1} = \frac{N_a + kT_hBG_a}{N_a + kT_cBG_a} \quad (3-15)$$

By substituting in eq (3-15) from (3-11) for N_a

$$Y = \frac{kT_cBG_a + kT_hBG_a}{kT_eBG_a + kT_cBG_a} \quad (3-16)$$

or

$$Y = \frac{T_e + T_h}{T_e + T_c} \quad (3-17)$$

Solving this equation for T_e gives

$$T_e = \frac{T_h - YT_c}{Y - 1} \quad \text{Q.E.D.}$$

Relation V.

$$F = \frac{\left(\frac{T_h}{T_o} - 1\right) - Y \left(\frac{T_c}{T_o} - 1\right)}{Y - 1} \quad (3-18)$$

Using eq (3-10) and substituting (3-13) for T_e gives

$$F = \frac{\frac{T_h - YT_c}{Y - 1} + T_o}{T_o} \quad (3-19)$$

or

$$F = \frac{T_h - YT_c + YT_o - T_o}{T_o(Y - 1)} \quad (3-20)$$

or

$$F = \frac{\frac{T_h}{T_o} - 1 - Y \left(\frac{T_c}{T_o} - 1\right)}{Y - 1} \quad \text{Q.E.D.}$$

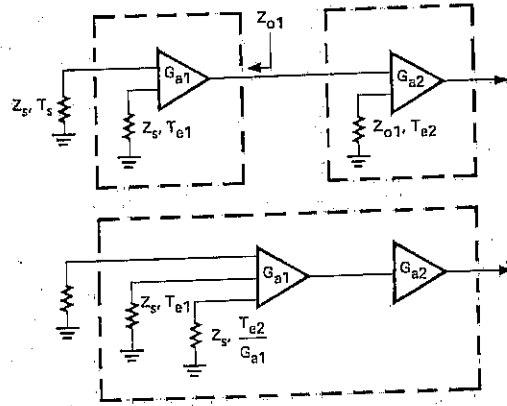

Figure 3.1. A cascade of two stages where each stage contributes its own noise (represented by T_{e1} or T_{e2}) and processes (amplifies) the noise power available from the previous stage.

Relation VI. The Cascade Effect

$$T_{e12} = T_{e1} + \frac{T_{e2}}{G_{a1}} \quad (3-21)$$

Figure 3-1 shows cascaded stages where each stage has an input composed of the sum of two effects: (1) The T_e of that stage, and (2) the noise power available at the input. The power available from the source is kT_sB where the bandwidth, B , is assumed to be determined by the power measurement. The power available at the output of the first stage is (using eq (3-9) for N_a

$$P_{a1} = kT_sBG_{a1} + kT_{e1}BG_{a1} \quad (3-22)$$

The power available at the output of the second stage is

$$P_{a2} = P_{a1}G_{a2} + kT_{e2}BG_{a2} \quad (3-23)$$

or

$$P_{a2} = kT_sBG_{a1}G_{a2} + kT_{e1}BG_{a1}G_{a2} + kT_{e2}BG_{a2} \quad (3-24)$$

But P_{a2} can also be written considering the two stages as a single entity with available gain G_{a12} and effective input noise temperature T_{e12}

$$P_{a2} = kT_sBG_{a12} + kT_{e12}BG_{a12} \quad (3-25)$$

But G_{a12} is the equivalent to the product $G_{a1}G_{a2}$. Using this equivalence and equating (3-24) to (3-25)

$$kBG_{a2}(T_sG_{a1} + T_{e1}G_{a1} + T_{e2}) = kBG_{a2}(T_sG_{a1} + T_{e12}G_{a1}) \quad (3-26)$$

Solving for T_{e12} gives

$$T_{e12} = T_{e1} + \frac{T_{e2}}{G_{a1}}$$

Q.E.D.

Relation VII.

$$F_{12} = F_1 + \frac{F_2 - 1}{G_{a1}} \quad (3-27)$$

Eq (3-10) can be solved for T_e to give

$$T_e = T_o (F - 1) \quad (3-28)$$

Substituting this equation into (3-21) several times while denoting the individual T_e 's and F 's by the appropriate subscripts gives

$$T_o (F_{12} - 1) = T_o (F_1 - 1) + \frac{T_o (F_2 - 1)}{G_{a1}} \quad (3-29)$$

which simplifies to

$$F_{12} = F_1 + \frac{F_2 - 1}{G_{a1}} \quad \text{Q.E.D.}$$

4. Glossary

Symbols and Glossary Terms

B	Noise Bandwidth
$ b_s ^2$	Power delivered by a generator to a non-reflecting load
DSB	Double Sideband (see Single Sideband)
ENR	Excess Noise Ratio
F	Noise Figure
F_{min}	Minimum Noise Figure
1/f	Flicker Noise
G	Power Gain
G_{ass}	Associated Gain
G_a	Available Gain
G_i	Insertion Gain
G_s	Signal Gain
G_t	Transducer Gain
G/T	Gain to Temperature Ratio
K	Kelvins (Unit of Temperature)
k	Boltzmann's Constant
M	Noise Measure
M_u	Mismatch Uncertainty
N_a	Noise Added
NF	Noise Figure
N_{off}	= N_1 (see Y Factor)
N_{on}	= N_2 (see Y Factor)
N_1	N_{out} for T_c (see Y Factor)
N_2	N_{out} for T_h (see Y Factor)
R_n	Equivalent Noise Resistance
r_n	Equivalent Noise Resistance
RSS	Root Sum-of-the-squares
SSB	Single Sideband
S_{21}	Forward Transmission Coefficient
T_a	Noise Temperature
T_c, T_c	Cold Temperature (see T_c)
T_e	Effective Input Noise Temperature
T_h, T_h	Hot Temperature (see T_h)
T_{ne}	Effective Noise Temperature
T_{off}	Off Temperature (see T_{off})
T_{on}	On Temperature (see T_{on})
T_{op}	Operating Noise Temperature
T_o	Standard Noise Temperature (290K)
Γ_{opt}	Optimum Reflection Coefficient

Associated Gain (G_{ass}). The available gain of a device when the source reflection coefficient is the optimum reflection coefficient Γ_{opt} .

Available Power Gain (G_a). [2] The ratio, at a specific frequency, of power available from the output of the network P_{ao} to the power available from the source P_{as} .

$$G_a = \frac{P_{ao}}{P_{as}} \quad (1)$$

For a source with output $|b_s|^2$ and reflection coefficient Γ_s

$$P_{as} = \frac{|b_s|^2}{1 - |\Gamma_s|^2} \quad (2)$$

$$P_{ao} = \frac{|b_s|^2 |S_{21}|^2 (1 - |\Gamma_2|^2)}{|(1 - \Gamma_s S_{11}) (1 - \Gamma_2^* S_{22}) - \Gamma_s \Gamma_2^* S_{12} S_{21}|^2} \quad (3)$$

where

$$\Gamma_2 = S_{22} + \frac{S_{12} S_{21} \Gamma_s}{1 - S_{11} \Gamma_s} \quad (4)$$

An alternative expression for the available output power is

$$P_{ao} = \frac{|b_s|^2 |S_{21}|^2}{|1 - \Gamma_s S_{11}|^2 (1 - |\Gamma_2|^2)} \quad (5)$$

These lead to two expressions for G_a .

$$G_a = |S_{21}|^2 \frac{(1 - |\Gamma_s|^2)(1 - |\Gamma_2|^2)}{|(1 - \Gamma_s S_{11}) (1 - \Gamma_2^* S_{22}) - \Gamma_s \Gamma_2^* S_{12} S_{21}|^2} \quad (6)$$

$$G_a = |S_{21}|^2 \frac{1 - |\Gamma_s|^2}{|1 - \Gamma_s S_{11}|^2 (1 - |\Gamma_2|^2)} \quad (7)$$

NOTE: G_a is a function of the network parameters and of the source reflection coefficient Γ_s . G_a is independent of the load reflection coefficient Γ_l .

G_a is often expressed in dB

$$G_a(\text{dB}) = 10 \log \frac{P_{ao}}{P_{as}} \quad (8)$$

Avalanche Diode Noise Source. [10, 11, 12, 14, 19, 20] A noise source that depends on the noise generated in a solid state diode that is reverse biased into the avalanche region. Such noise sources have become very popular because of their small size and low power requirements. Recent design advances have produced noise sources that are stable with time, have a broad frequency range and a low reflection coefficient. Excess noise ratios of well matched devices are usually about 15 dB ($T_{ne} \approx 10000\text{K}$). Higher excess noise ratios are possible by sacrificing impedance match and flat frequency response.

Bandwidth (B). See noise bandwidth.

Boltzmann's Constant (k). 1.38×10^{-23} joules/kelvin.

Cascade Effect. [7]. The relationship, when several networks are connected in cascade, of the noise characteristics (F or T_e and G_a) of each individual network to the noise characteristics of the overall or combined network (see Appendix). If F_1, F_2, \dots, F_n (numerical ratios, not dB) are the individual noise figures and $G_{a1}, G_{a2}, \dots, G_{an}$ (numerical ratios) are the individual available gains, the combined noise figure is

$$F = F_1 + \frac{F_2 - 1}{G_{a1}} + \frac{F_3 - 1}{G_{a1}G_{a2}} + \dots + \frac{F_n - 1}{G_{a1}G_{a2} \dots G_{a(n-1)}} \quad (1)$$

the combined available gain is

$$G_a = G_{a1}G_{a2} \dots G_{an} \quad (2)$$

In terms of individual effective input noise temperatures $T_{e1}, T_{e2}, \dots, T_{en}$ the overall effective input noise temperature is

$$T_e = T_{e1} + \frac{T_{e2}}{G_{a1}} + \frac{T_{e2}}{G_{a1}G_{a2}} + \dots + \frac{T_{en}}{G_{a1}G_{a2} \dots G_{a(n-1)}} \quad (3)$$

NOTE: Each F_i , T_{ei} , and G_{ai} above refers to the value for the source impedance that corresponds to the output impedance of the previous stage.

Diode Noise Source. See "Avalanche Diode Noise Source" for a solid state noise source and "Thermionic Diode Noise Source" for a vacuum diode noise source.

Double Sideband (DSB). See Single Sideband (SSB).

Effective Input Noise Temperature (T_e). [16] The noise temperature assigned to the impedance at the input port of a DUT which would, when connected to a noise-free equivalent of the DUT, yield the same output power as the actual DUT when it is connected to a noise-free input port impedance. The same temperature applies simultaneously for the entire set of frequencies that contribute to the output frequency. If there are several input ports, each having a specified impedance, the same temperature applies simultaneously to all the ports. All ports except the output are to be considered input ports for purposes of defining T_e .

NOTE 1: A noise-free equivalent of the DUT is one for which all internal (inaccessible) noise sources are removed, and for which the termination at the output is noise free.

NOTE 2: T_e depends on the impedance at the output port and the noise temperature of the impedance at frequencies other than the specified output frequency although the effect is usually very small.

NOTE 3: For a two-port transducer with a single input and a single output frequency, T_e is related to the noise figure F by

$$T_e = 290(F-1) \quad (1)$$

Effective Noise Temperature (T_{ne}). [1] (This is a property of a one-port, i.e., a noise source.) The temperature that yields the power emerging from the output port of the noise source when it is connected to a nonreflecting, nonemitting

load. The relationship between the noise temperature T_a and effective noise temperature T_{ne} is

$$T_{ne} = T_a (1 - |\Gamma|^2) \quad (1)$$

where Γ is the reflection coefficient of the noise source. The proportionality factor for the emerging power is kB so that

$$T_{ne} = \frac{P_e}{(kB)} \quad (2)$$

where P_e is the emerging power, k is Boltzmann's constant, and B is the bandwidth of the power measurement. The power spectral density across the measurement bandwidth is assumed to be constant.

Equivalent Noise Resistance (r_n or R_n). See "Noise Figure Circles".

Excess Noise Ratio (ENR). [1] A noise generator property calculated from the effective noise temperature (T_{ne}) using the equation

$$ENR = 10 \log \frac{T_{ne} - T_o}{T_o} \quad (1)$$

where T_o is the standard temperature of 290K. Note well that this definition refers, through T_{ne} , to the emerging power into a nonreflecting, nonemitting load and does not refer to the power delivered to a conjugate load. Many noise figure experts have used a different definition (see, e.g., [22]). They tend to use eq (1) with noise temperature T_a , instead of T_{ne} , because T_a can often be found, at least in principle, from the physical temperature or calculations. T_{ne} and ENR is what is calibrated by the United States National Bureau of Standards (NBS). Most engineers working in noise figure interchangeably use T_a and T_{ne} in eq (1). They refer to both as T_h .

A few examples of the relationship between ENR and T_{ne} may be worthwhile. An ENR of 0 dB corresponds to $T_{ne} = 580K$. T_h of 100°C (373K) corresponds to an ENR of -5.43 dB. T_{ne} of 290K corresponds to an ENR of $-\infty$ dB.

Flicker Noise and 1/f Noise. [29,33] Any noise whose power spectral density varies inversely with frequency. Especially important at audio frequencies or with GASFET's below about 100 MHz. Most causes of 1/f noise are not well understood. One cause of 1/f noise in vacuum tubes is the slowly varying condition of the cathode. In transistors 1/f noise is thought to be partially due to inhomogeneities and surface effects.

Forward Transmission Coefficient (S_{21}). The ratio, at a specific frequency, of the power delivered by the output of a network, to the power delivered to the input of the network

when the network is terminated by a nonreflecting load and excited by a nonreflecting generator.

The magnitude of this parameter is often given in dB.

$$|S_{21}|^2 \text{ (dB)} = 10 \log |S_{21}|^2 \quad (1)$$

Friis Formula. See Cascade Effect.

Gain to Temperature Ratio (G/T). [28,34] A figure of merit for a satellite or radio astronomy receiver system, including the antenna, that portrays the operation of the total system. The numerator is the antenna gain, the denominator is the operating noise temperature of the receiver. The ratio is usually expressed in dB, i.e., $10 \log(G/T)$. G/T is often measured by comparing the receiver response when the antenna input is a "hot" celestial noise source to the response when the input is the background radiation of space ($\approx 3K$).

Gas Discharge Noise Source. [22,23] A noise source that depends on the temperature of an ionized noble gas. This type of noise source usually requires several thousand volts to begin the discharge but only about a hundred volts to sustain the discharge. Components of the high turn-on voltage sometimes feed through the output to damage certain small, frail, low-noise, solid-state devices. The gas discharge noise source has been replaced by the avalanche diode noise source in most applications. Gas discharge noise sources, however, are still used for calibration purposes at the United States National Bureau of Standards because of low measurement uncertainty and proven long-term stability. Gas discharge tubes are still widely used at millimeter wavelengths. Excess noise ratios (ENR) for argon tubes is about 15.5 dB (10000K).

Gaussian Noise. [5] Noise whose probability distribution or probability density function is gaussian, that is, it has the standard form

$$p(x) = \frac{1}{\sigma \sqrt{2\pi}} e^{-\frac{x^2}{2\sigma^2}} \quad (1)$$

where σ is the standard deviation. Noise that is steady or stationary in character and originates from the sum of a large number of small events, tends to be gaussian by the central limit theorem of probability theory. Thermal noise and shot noise are gaussian.

Hot/Cold Noise Source. In one sense most noise figure measurements depend on noise power measurements at two source temperatures — one hot and one cold. The expression "Hot/Cold," however, frequently refers to measurements made with a cold termination at liquid nitrogen temperatures (77K) or even liquid helium (4K), and a hot

termination at 373K (100°C). Such terminations are sometimes used as primary standards and for highly accurate calibration laboratory measurements.

Insertion Gain (G_i). The gain that is measured by inserting the DUT between a generator and load. The numerator of the ratio is the power delivered to the load while the DUT is inserted, P_d. The denominator, or reference power P_r, is the power delivered to the load while the source is directly connected. Measuring the denominator might be called the calibration step.

$$G_i = \frac{P_d}{P_r} \quad (1)$$

The load power while the source and load are directly connected is

$$P_r = |b_r|^2 \frac{1 - |\Gamma_1|^2}{|1 - \Gamma_1 \Gamma_s|^2} \quad (2)$$

where the subscript "r" denotes the source characteristics while establishing the reference power, i.e., during the calibration step. The load power while the DUT is inserted is

$$P_d = |b_d|^2 |S_{21}|^2 \frac{1 - |\Gamma_1|^2}{|(1 - \Gamma_{sd} S_{11})(1 - \Gamma_1 S_{22}) - \Gamma_1 \Gamma_{sd} S_{12} S_{21}|^2} \quad (3)$$

or

$$P_d = |b_d|^2 |S_{21}|^2 \frac{1 - |\Gamma_1|^2}{|1 - \Gamma_{sd} S_{11}|^2 |1 - \Gamma_1 \Gamma_2|^2} \quad (4)$$

where

$$\Gamma_2 = S_{22} + \frac{S_{12} S_{21} \Gamma_{sd}}{1 - \Gamma_{sd} S_{11}} \quad (5)$$

In equations (3,4, and 5) the subscript "d" denotes the source characteristics while the DUT is inserted. The S parameters refer to the DUT. The source characteristics while calibrating and while the DUT is inserted are sometimes different. Consider that the DUT, for example, is a microwave receiver with a waveguide input and an IF output at 70 MHz. During the calibration step, the source has a coaxial output at 70 MHz, but while the DUT is inserted the source has a waveguide output at the microwave frequency. Using the above equations, insertion gain is

$$G_i = |S_{21}|^2 \frac{|b_d|^2}{|b_r|^2} \frac{|1 - \Gamma_1 \Gamma_{sr}|^2}{|(1 - \Gamma_{sd} S_{11})(1 - \Gamma_1 S_{22}) - \Gamma_1 \Gamma_{sd} S_{12} S_{21}|^2} \quad (6)$$

or

$$G_i = |S_{21}|^2 \frac{|b_d|^2}{|b_r|^2} \frac{|1 - \Gamma_1 \Gamma_{sr}|^2}{|1 - \Gamma_{sd} S_{11}|^2 |1 - \Gamma_1 \Gamma_2|^2} \quad (7)$$

In those situations where the same source at the same frequency is used during the calibration step and DUT insertion, $|b_d|^2 = |b_r|^2$ and $\Gamma_{sr} = \Gamma_{sd}$. This is usually the case when measuring amplifiers.

Instrumentation Uncertainty. The uncertainty caused by errors within the circuits of electronic instruments. For noise figure meters this includes errors due to the detector, A/D converter, math round-off effects, any mixer nonlinearities, saturation effects, and gain instability during measurement. This uncertainty is often mistakenly taken as the overall measurement accuracy because it can be easily found on specification sheets. With modern techniques, however, it is seldom the most significant cause of uncertainty.

Johnson Noise. [18] The same as thermal noise.

Minimum Noise Figure (F_{min}). See "Noise Figure Circles".

Mismatch Uncertainty (M_U). Mismatch uncertainty is caused by re-reflections between one device (the source) and the device that follows it (the load). The re-reflections cause the power emerging from the source (incident to the load) to change from its value with a reflectionless load.

An expression for the power incident upon the load, which includes the effects of re-reflections, is

$$P_i = \frac{|b_s|^2}{|1 - \Gamma_s \Gamma_l|^2} \quad (1)$$

where $|b_s|^2$ is the power the source delivers to a nonreflecting load, Γ_s is the source reflection coefficient, and Γ_l is the load reflection coefficient. If accurate evaluation of the power incident is needed when $|b_s|^2$ is given or vice versa, then the phase and magnitude of Γ_s and Γ_l is needed — probably requiring a vector network analyzer.

When the phase of the reflection coefficients is not known, the extremes of $|1 - \Gamma_s \Gamma_l|^2$ can be calculated from the magnitudes of Γ_s and Γ_l , i.e., ρ_s and ρ_l . The extremes of $|1 - \Gamma_s \Gamma_l|^2$ in dB can be found from the nomograph (Figure 4-1) or from the HP Reflectometer/Mismatch Error Limits Calculator.*

The effect of mismatch on noise figure measurements is extremely complicated to analyze. Consider, for example, a

*A complimentary HP Reflectometer/Mismatch Error Limits Calculator is available from any Hewlett-Packard sales office, or write to Inquiry Mgr. at 1820 Embarcadero Road, Palo Alto, CA 94303. Ask for Literature No. 5952-0948.

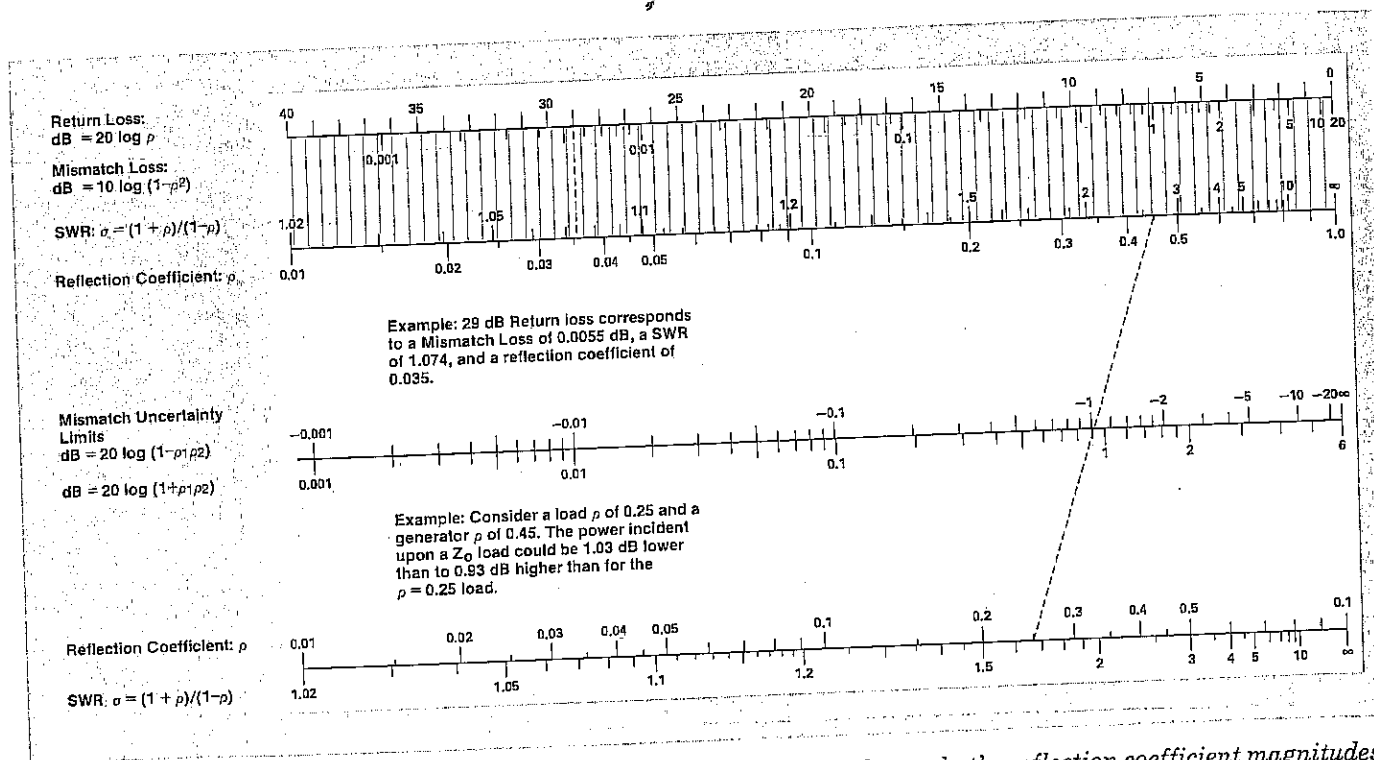

Figure 4-1. This nomograph gives the extreme effects of re-reflections when only the reflection coefficient magnitudes are known. Mismatch uncertainty limits of this nomograph apply to noise figure measurement accuracy for devices that include an isolator at the input.

noise source whose impedance is not quite 50 ohms. The source takes part in re-reflections of its own generated noise, but it also reflects noise originating in the DUT and emerging from the DUT input (noise added by a DUT, after all, is a function of the source impedance). The changed source impedance also causes the DUT's available gain to change (remember that available gain is also a function of source impedance). The situation can be complicated further because the source impedance can change between the hot state and the cold state. Many attempts have been made to establish a simple rule-of-thumb for evaluating the effect of mismatch — all with limited success. One very important case was analyzed by Strid [30] to have a particularly simple result. Strid considered the DUT to include an isolator at the input with sufficient isolation to prevent interaction of succeeding devices with the noise source. The effect of noise emerging from the isolator input and re-reflections between the isolator and noise source are included in the final result. The result is that the error in noise figure is

$$\Delta F \text{ (dB)} = F_{\text{act}} \text{ (dB)} - F_{\text{ind}} \text{ (dB)} \quad (2)$$

$$= 10 \log \frac{1}{|1 - S_{11} \Gamma_{\text{sh}}|^2} \quad (3)$$

where F_{act} is the noise figure for a reflectionless noise source, F_{ind} is the measured noise figure, S_{11} is the reflection coefficient looking into the DUT, i.e., into the isolator input, and Γ_{sh} is the reflection coefficient looking back into the noise source when in the hot or on condition. Strid also assumed that the isolator and T_{cold} are both 290K. Note that the result is independent of the DUT noise figure, Y factor, and the noise source reflection coefficient for T_{cold} .

Mismatch uncertainty may also occur while characterizing the noise contribution of the measurement system and also at the output of DUT during gain measurement. Gain measurement mismatch effects can be calculated by evaluating the difference between available gain and insertion gain.

Mismatch uncertainty is often the most significant uncertainty in noise figure measurements. Correction usually requires full noise characterization (see "Noise Figure Circles") and measurement of phase and amplitude of the reflection coefficients.

N_1 . See "Y Factor".

N_2 . See "Y Factor".

N_{off} . Same as N_1 . See "Y factor".

N_{on} . Same as N_2 . See "Y factor."

Noise Added (N_a). The component of the output noise power that arises from sources within the network under test. This component of output noise is usually differentiated from the component that comes from amplifying the noise that originates in the input source for the network. Occasionally the noise added is referred to the input port, i.e., the added noise power at the output is divided by G_a or G_t .

Noise Bandwidth (B). [17, 23] An equivalent rectangular pass band that passes the same amount of noise power as the actual system being considered. The height of the pass band is the transducer power gain at some reference frequency. The reference frequency is usually chosen to be either the band center or the frequency of maximum gain. The area under the equivalent (rectangular) gain vs. frequency curve is equal to the area under the actual gain vs. frequency curve. In equation form

$$B = \int_0^{\infty} \frac{G(f)df}{G_0} \quad (1)$$

where G_0 is the gain at the reference frequency. For a multistage system, the noise bandwidth is nearly equal to the 3 dB bandwidth.

Noise Figure and Noise Factor (NF and F). [6] At a specified input frequency, noise figure is the ratio of (1) the total noise power/hertz at a corresponding output frequency available at the output port when the noise temperature of the input termination is standard (290K) at all frequencies, to (2) that portion of the output power engendered by the input termination.

The output noise power is often considered to have two components — added noise from the device, N_a , and amplified input noise, i.e., the output power from the input termination amplified by the DUT, kT_oBG_a . Then noise figure can be written

$$F = \frac{N_a + kT_oBG_a}{kT_oBG_a} \quad (1)$$

NOTE 1: For heterodyne systems, there will be, in principle, more than one input frequency for a single output frequency and vice versa. For each pair of corresponding frequencies a noise figure is defined. The denominator, (2) above, includes only that noise from the input termination which appears in the output via the principal frequency transformation of the system, i.e., via the signal-frequency transformation(s). It does not include spurious contributions such as those from an unused image-frequency or an unused idler-frequency transformation.

NOTE 2: The phrase "available at the output port" may be replaced by "delivered by system into an output termination". Using the "delivered power" instead of the "available power," however, complicates the use of the Friis formula for cascaded devices.

NOTE 3: Characterizing a system by noise figure is meaningful only when the impedance (or its equivalent) of the input termination is specified.

Noise figure and noise factor are sometimes differentiated by [27]

$$\text{Noise Figure} = 10 \log (\text{Noise Factor}) \quad (1)$$

so that noise figure is in dB and noise factor is the numerical ratio. Other times the terms are used interchangeably. There should be no confusion, however, because the symbol "dB" seems to be invariably used when $10 \log (\text{NF})$ has been taken. No "dB" symbol implies that the numerical ratio is meant.

Noise Figure Circles. [8,17] This refers to the contours of constant noise figure for a network when plotted on the complex plane of the source impedance, admittance, or reflection coefficient seen by the network. The general equation expressing the noise figure of a network as a function of source reflection coefficient Γ_s is

$$F = F_{\min} + \frac{4R_n}{Z_0} \cdot \frac{|\Gamma_{\text{opt}} - \Gamma_s|^2}{|1 + \Gamma_{\text{opt}}|^2 (1 - |\Gamma_s|^2)} \quad (1)$$

where Γ_{opt} is the source reflection coefficient that results in the minimum noise figure of the network, F_{\min} is the minimum noise figure, Z_0 is the reference impedance for defining Γ_s (usually 50 ohms) and R_n is called the equivalent noise resistance. Sometimes R_n/Z_0 is given as the single parameter r_n , called the normalized equivalent noise resistance. Loci of constant F , plotted as a function of Γ_s , form circles on the complex plane. Noise figure circles with available gain circles are highly useful for circuit designer insight into optimizing the overall network for low noise figure and flat gain.

Noise Measure (M). [13] A quality factor that includes both the noise figure and gain of a network as follows

$$M = \frac{(F-1)}{1 - \frac{1}{G}} \quad (1)$$

If two amplifiers with different noise figures and gains are to be cascaded, the amplifier with the lowest M should be used at the input to achieve the smallest overall noise figure. Like noise figure and available power gain, a network's noise measure generally varies with source impedance [8]. To make the decision as to which amplifier to

place first, the source impedances must be such that F and G for each amplifier are independent of the order of cascading.

Noise measure is also used to express the overall noise figure of an infinite cascade of identical networks. The overall noise figure is

$$F_{\text{tot}} = F + \frac{F-1}{G_a} + \frac{F-1}{G_a^2} + \frac{F-1}{G_a^3} + \dots \quad (2)$$

$$F_{\text{tot}} = 1 + \frac{F-1}{1 - \frac{1}{G_a}} \quad (3)$$

$$F_{\text{tot}} = 1 + M \quad (4)$$

Sometimes F_{tot} of equation (2) is called the noise measure instead of M in equation (1). Care should be exercised as to which definition is being used — they differ by 1.

Noise Temperature (T_a). [1] The temperature that yields the available power spectral density from a source. It is obtained when the corresponding reflection coefficients for the generator and load are complex conjugates. The relationship to the available power P_a is

$$T_a = \frac{P_a}{kB} \quad (1)$$

where k is Boltzmann's constant and B is the bandwidth of the power measurement. The power spectral density across the measurement band is to be constant. Also see Effective Noise Temperature (T_{ne}).

Noise temperature can be equivalently defined [23] as the temperature of a passive source resistance having the same available noise power spectral density as that of the actual source.

Nyquist's Theorem. See "Thermal Noise".

Operating Noise Temperature (T_{op}). [6] The temperature in kelvins given by:

$$T_{op} = \frac{N_o}{kG_s} \quad (1)$$

where N_o is the output noise power/hertz from the DUT at a specified output frequency delivered into the output circuit under operating conditions, k is Boltzmann's constant, and G_s is the transducer power gain for the signal.

NOTE: In a linear two-port transducer with a single input and a single output frequency, T_{op} is related to the noise temperature of the input termination T_a , and the effective input noise temperature T_e , by:

$$T_{op} = T_a + T_e \quad (2)$$

Optimum Reflection Coefficient (Γ_{opt}). See "Noise Figure Circles".

Partition Noise. [23,33] An apparent additional noise source due to the random division of current among various electrodes or elements of a device.

Pink Noise. A noise spectrum whose power spectral density on a log frequency basis (i.e., watts/decade) is constant. The power spectral density varies as $1/f$. Pink noise is often formed by passing white noise through a filter with a 3 dB per octave rolloff. It is primarily used for testing systems with multi-decade bandwidths such as audio systems.

Power Gain (G). [2] The ratio, at a specific frequency, of power delivered by a network to an arbitrary load P_1 to the power delivered to the network by the source P_s .

$$G = \frac{P_1}{P_s} \quad (1)$$

The words "power gain" and the symbol G are often carelessly used when referring to noise, but what is probably intended is "available power gain (G_a)", or "transducer power gain (G_t)", or "insertion power gain (G_i)".

For an arbitrary source and load, the power gain of a network is given by

$$G = |S_{21}|^2 \frac{1 - |\Gamma_1|^2}{|1 - \Gamma_1 S_{22}|^2 (1 - |\Gamma_1|^2)} \quad (2)$$

where

$$\Gamma_1 = S_{11} + \frac{S_{12} S_{21} \Gamma_1}{1 - \Gamma_1 S_{22}} \quad (3)$$

NOTE 1: G is function of the load reflection coefficient and the scattering parameters of the network but is independent of the source reflection coefficient.

NOTE 2: The expression for G is the same as that for G_a if Γ_1 is substituted for Γ_s and S_{11} is substituted for S_{22} .

G is often expressed in dB

$$G(\text{dB}) = 10 \log \frac{P_1}{P_s} \quad (4)$$

Root sum-of-the-squares uncertainty (RSS). A method of combining several individual uncertainties of known limits to form an overall uncertainty. If a particular measurement has individual uncertainties $\pm A$, $\pm B$, $\pm C$, etc, then the RSS uncertainty is

$$U_{RSS} = (A^2 + B^2 + C^2 + \dots)^{1/2} \quad (1)$$

The RSS uncertainty is based on the fact that most of the errors of measurement, although systematic and not random, are independent of each other. Since they are independent they are random with respect to each other and combine like random variables.

Second-Stage Effect. A reference to the cascade effect during measurement situations where the DUT is the first stage and the measurement equipment is the second stage. The noise figure measured is the combined noise figure of the DUT cascaded to the measurement equipment. If F_2 is the noise figure of the measurement system alone, and F_{12} is the combined noise figure of the DUT and system, then F_1 , the noise figure of the DUT, is

$$F_1 = F_{12} - \frac{F_2 - 1}{G_{a1}} \quad (1)$$

where G_{a1} is the available gain of the DUT.

NOTE: F_2 in equation (1) is the noise figure of the measurement system for a source impedance corresponding to the output impedance of the DUT.

Sensitivity. The smallest signal that a network can reliably process. Sensitivity specifies the strength of the smallest signal at the input of a network that causes the output signal power to be M times the output noise power where M must be specified. $M=1$ is very popular. For a source temperature of 290K, the relationship of sensitivity to noise figure is

$$S_i = MkT_oBF \quad (1)$$

In dBm

$$S_i (\text{dBm}) = -174 \text{ dBm} + F(\text{dB}) + 10 \log B + 10 \log M \quad (2)$$

Thus sensitivity is directly related to noise figure in terrestrial systems once the bandwidth is known.

Shot Noise. [5, 33] Noise caused by the quantized and random nature of current flow. Carriers are emitted, injected or otherwise cross boundaries of devices in a random manner — giving rise to the noise. Shot noise, arising from a large number of small events, exhibits a gaussian probability distribution. The power spectral density is proportional to the current flowing and is often flat with frequency up to the frequency that is the reciprocal of the transit time.

Signal Gain (G_s). [6] The ratio of signal power delivered into the output circuit P_1 to the signal power available at the input P_{as}

$$G_s = \frac{P_1}{P_{as}} \quad (1)$$

Thus signal gain is the same as transducer gain.

Single-sideband (SSB). Refers to using only one of the two main frequency bands that get converted to an IF. In noise figure discussions, single-sideband is derived from the meaning attached to modulation schemes in communication systems where energy on one side of the carrier is suppressed to more optimally utilize the radio spectrum. Many noise figure measurements are in systems that include down conversion using a mixer and local oscillator at frequency f_{LO} to generate an intermediate frequency f_{IF} . The IF power from the mixer is usually increased by an amplifier having bandwidth B . Some of these down converting systems respond only to signals over bandwidth B centered at $f_{LO} + f_{IF}$. These are single-sideband measurements at the upper sideband (USB). Some other systems respond only to signals over bandwidth B centered at $f_{LO} - f_{IF}$. These are single-sideband measurements at the lower sideband (LSB). Other systems respond to signals in both bands. Such measurements are called double sideband (DSB). SSB systems usually use pre-selection filtering or image rejection to eliminate the unwanted sideband.

Confusion often arises when DSB noise figure measurement results for receivers or mixers are to be interpreted for single-sideband applications. The cause of the confusion is that the definition of noise figure (see the notes under "Noise Figure" in this glossary) states that the numerator should include noise from all frequency transformations of the system, including the image frequency and other spurious responses, but the denominator should only include the principal frequency transformation of the system. For systems that respond equally to the upper sideband and lower sideband, but where the intended frequency translation is to be for only one sideband, the denominator noise power in the definition should be half the total measured output power engendered by the input (assuming gain and bandwidth are the same in both bands). Double-sideband noise figure measurements normally do not make the distinction. Since the noise source contains noise at all frequencies, all frequency transformations are included in both the numerator and denominator. Thus, if the final application of the network being measured has desired signals in only one sideband but responds to noise in both sidebands, the denominator of DSB measurements is too large and the measured noise figure is too small — usually a factor of about two (3 dB).

There are occasions when the information in both sidebands is desired and processed. The measured DSB noise figure is proper and no correction should be performed. In

many of those applications, the signal being measured is radiation so the receiver is called a radiometer. Radiometers are very common in radio astronomy.

Noise figure measurements of amplifiers made with measurement systems that respond to both sidebands should not include a 3 dB correction factor. This was discussed in Chapter 1 under "Some Typical Noise Figures". In this case, the noise figure measurement system is operating as a radiometer because it is using the information in both sidebands.

Spot Noise Figure and Spot Noise Factor. A term used when it is desired to emphasize that the noise figure or noise factor pertains to a single frequency as opposed to being averaged over a broad band.

Standard Noise Temperature (T_0). [6] The standard reference temperature for noise figure measurements. It is defined to be 290K.

T_C , T_C , or T_{cold} . The colder of two noise source temperatures, usually in kelvins, used to measure a network's noise characteristics.

T_H , T_H , or T_{hot} . The hotter of two noise source temperatures, usually in kelvins, used to measure a network's noise characteristics.

T_{off} . The temperature, usually in kelvins, of a noise source when it is biased off. This corresponds to T_{cold} .

T_{on} . The temperature, usually in kelvins, of a noise source when it is biased on. This corresponds to T_{hot} .

Thermal Noise. [18,23,26] The fluctuating voltage across a resistance due to the random motion of free charge caused by thermal agitation. The probability distribution of the voltage is gaussian with mean square voltage

$$\overline{e_n^2} = 4kT \int_{f_1}^{f_2} R(f)p(f)df \quad (1)$$

for

$$p(f) = \frac{hf}{kT} \left(e^{\frac{hf}{kT}} - 1 \right)^{-1} \approx 1 \quad (2)$$

where k is Boltzmann's constant (1.38×10^{-23} joules/kelvin), T is the absolute temperature in kelvins, R is the resistance in ohms, f is the frequency in hertz, f_1 and f_2 specify the band over which the voltage is observed, and h is the Planck's constant (6.62×10^{-34} joule seconds). For frequencies below 100 GHz and for $T = 290K$, $1 > p(f) > 0.992$, so $p(f) = 1$ and equation (1) becomes

$$\begin{aligned} \overline{e_n^2} &= 4 kTR(f_2 - f_1) \\ &= 4 kTRB \end{aligned} \quad (3)$$

The power available, that is, the power delivered to a complex conjugate load at absolute zero, is

$$\begin{aligned} P_a &= \frac{\overline{e_n^2}}{4R} \\ &= kT(f_2 - f_1) \\ &= kTB \end{aligned} \quad (4)$$

The available power spectral density is kT watts/hertz. Although this development appears to make eq (3) more fundamental than (4), Nyquist[26] first arrived at the value of power spectral density (eq (4)) and then calculated the voltage and current involved (eq (3)). The expression for the voltage generator is

$$e_n^2 df = 4 RkT df \quad (5)$$

Equation (5) is frequently referred to as Nyquist's Theorem. This should not be confused with Nyquist's work in other areas such as sampling theory and stability criteria where other relations may also be referred to as Nyquist's Theorem. When T is equal to the standard temperature T_0 (290K), $kT_0 = 4 \times 10^{-21}$ W/Hz = -174 dBm/Hz.

Thermionic Diode Noise Source. [5, 23, 29, 33] A noise source that depends on the shot noise in a vacuum diode operated in the temperature limited region. In the 1950's and 60's the thermionic diode noise source was popular for the IF and VHF ranges but since then has been largely replaced by the avalanche diode noise source. Excess noise ratios (ENR) tend to be about 5 dB ($T_{ne} \approx 1200K$).

Transducer Power Gain (G_t). [2] The ratio, at a specific frequency, of power delivered by a network to an arbitrary load P_1 to the power available from the source P_{as}

$$G_t = \frac{P_1}{P_{as}} \quad (2)$$

For a source of strength $|b_s|^2$ and reflection coefficient Γ_s , and for a load reflection coefficient Γ_1 ,

$$P_{as} = \frac{|b_s|^2}{1 - |\Gamma_s|^2} \quad (2)$$

$$P_1 = \frac{|b_s|^2 |S_{21}|^2 (1 - |\Gamma_1|^2)}{|(1 - \Gamma_s S_{11})(1 - \Gamma_1 S_{22}) - \Gamma_1 \Gamma_s S_{12} S_{21}|^2} \quad (3)$$

where the S parameters refer to the DUT. An equivalent expression for P_1 is

$$P_1 = \frac{|b_s|^2 |S_{21}|^2 (1 - |\Gamma_1|^2)}{|1 - \Gamma_s S_{11}|^2 |1 - \Gamma_1 \Gamma_2|^2} \quad (4)$$

where

$$\Gamma_2 = S_{22} + \frac{S_{12} S_{21} \Gamma_s}{1 - \Gamma_s S_{11}} \quad (5)$$

Transducer gain is then

$$G_t = |S_{21}|^2 \frac{(1 - |\Gamma_s|^2)(1 - |\Gamma_1|^2)}{|(1 - \Gamma_s S_{11})(1 - \Gamma_1 S_{22}) - \Gamma_1 \Gamma_s S_{12} S_{21}|^2} \quad (6)$$

$$G_t = |S_{21}|^2 \frac{(1 - |\Gamma_s|^2)(1 - |\Gamma_1|^2)}{|1 - \Gamma_s S_{11}|^2 |1 - \Gamma_1 \Gamma_2|^2} \quad (7)$$

Transducer gain is a function of the source and load reflection coefficients as well as the network parameters.

The term "transducer" arises because the result compares the power delivered to an arbitrary load from an arbitrary generator through the DUT with the power delivered to the load through a lossless transducer which transfers all of the available generator power to the load.

Transducer gain is often measured in dB

$$G_t \text{ (dB)} = 10 \log \frac{P_1}{P_{as}} \quad (8)$$

White Noise. Noise whose power spectral density (watts/hertz) is constant for the frequency range of interest. The term "white" is borrowed from the layman's concept of white light being a composite of all colors, hence containing all frequencies.

Worst Case Uncertainty. A conservative method of combining several individual measurement uncertainties of known limits to form an overall measurement uncertainty. Each individual uncertainty is assumed to be at its limit in the direction that causes it to combine with the other individual uncertainties to have the largest effect on the measurement result. The deviation of the calculated measurement result from the result that would be achieved if each individual cause of uncertainty were totally removed is the worst case uncertainty.

Y Factor. The ratio of N_2 to N_1 in noise figure measurements where N_2 is the measured noise power output from the network under test when the source impedance is turned ON or at its hot temperature and N_1 is the measured power output when the source impedance is turned OFF or at its cold temperature.

REFERENCES

1. "Accuracy Information Sheet", United States National Bureau of Standards (NBS), enclosure returned with noise sources sent to NBS for calibration.
2. Anderson, R.W. "S-Parameter Techniques for Faster, More Accurate Network Design", Hewlett-Packard Application Note 95-1.
3. Beatty, Robert W. "Insertion Loss Concepts," Proc. of the IEEE, June, 1964, pp. 663-671.
4. Chambers, D. R. "A Noise Source for Noise Figure Measurements," Hewlett-Packard J., April, 1963, pp. 26-27.
5. Davenport, Wilbur B. Jr. and William L. Root. "An Introduction to the Theory of Random Signals and Noise," McGraw-Hill Book Co., Inc, New York, Toronto, London, 1958.
6. "Description of the Noise Performance of Amplifiers and Receiving Systems", Sponsored by IRE subcommittee 7.9 on Noise, Proc. of the IEEE, March, 1963, pp. 436-442.
7. Friis, H.T. "Noise Figures of Radio Receivers", Proc. of the IRE, July, 1944, pp. 419-422.
8. Fukui, H. "Available Power Gain, Noise Figure and Noise Measure of Two-Ports and Their Graphical Representations," IEEE Trans. on Circuit Theory, June, 1966, pp. 137-143.
9. Fukui, H. (editor) "Low Noise Microwave Transistors and Amplifiers," IEEE Press and John Wiley & Sons, New York, 1981. (This book of reprints contains many of the articles referenced here.)
10. Gupta, M-S. "Noise in Avalanche Transit-Time Devices," Proc. of the IEEE, Dec., 1971, pp. 1674-1687.
11. Haitz, R.H. and F.W. Voltmer. "Noise Studies in Uniform Avalanche Diodes," Appl. Phys. Lett, 15 Nov., 1966, pp. 381-383.
12. Haitz, R.H. and F.W. Voltmer. "Noise of a Self-Sustaining Avalanche Discharge in Silicon: Studies at Microwave Frequencies," J. Appl. Phys., June, 1968, pp. 3379-3384.
13. Haus, H.A. and R.B. Adler. "Optimum Noise Performance of Linear Amplifiers," Proc. of the IRE, August, 1958, pp. 1517-1533.
14. Hines, M.E. "Noise Theory for the Read Type Avalanche Diode," IEEE Trans. on Electron devices, Jan., 1966, pp. 158-163.
15. "IRE Standards on Electron Tubes. Part 9, Noise in Linear Two-Ports," IRE subcommittee 7.9, Noise, 1957.
16. "IRE Standards on Electron Tubes: Definitions of Terms, 1962 (62 IRE 7.52)," Proc. of the IEEE, March, 1963, pp. 434-435.
17. "IRE Standards on Methods of Measuring Noise in Linear Twoports, 1959," IRE Subcommittee on Noise, Proc. of the IRE, January, 1960, pp. 60-68. See also "Representation of Noise in Linear Twoports," Proc. of the IRE, January, 1960, pp. 69-74.
18. Johnson, J.B. "Thermal Agitation of Electricity in Conductors", Physical Review, July, 1928, pp. 97-109.
19. Kanda, M. "A Statistical Measure for the Stability of Solid State Noise Sources," IEEE Trans. on Micro. Th. and Tech, August, 1977, pp. 676-682.
20. Kanda, M. "An Improved Solid-State Noise Source," IEEE Trans. on Micro, Th. and Tech, Dec., 1976, pp. 990-995.
21. Kuhn, N.J. "Simplified Signal Flow Graph Analysis," Microwave Journal, November 1963, pp. 59-66.
22. Mumford, W.W. "A Broadband Microwave Noise Source," Bell Syst. Tech. J., October, 1949, pp. 608-618.
23. Mumford, W.W. and Elmer H. Scheibe. "Noise Performance Factors in Communication Systems", Horizon House-Microwave, Inc., Dedham, Massachusetts, 1968.
24. NBS Monograph 142, "The Measurement of Noise Performance Factors: A Metrology Guide," U.S. Government Printing Office, Washington, D.C., 1974.
25. NBS Technical Note 640, "Considerations for the Precise Measurement of Amplifier Noise," U.S. Government Printing Office, Washington, D.C., 1973.
26. Nyquist, H. "Thermal Agitation of Electric Charge in Conductors", Physical Review, July, 1928, pp. 110-113.
27. Oliver, B.M. "Noise Figure and Its Measurement", Hewlett-Packard Journal, Vol. 9, No. 5 (Jan., 1958), pp. 3-5.

28. Saam, Thomas J. "Small Computers Revolutionize G/T Tests," *Microwaves*, August, 1980, p. 37.
29. Schwartz, Mischa. "Information Transmission, Modulation and Noise," McGraw-Hill Book Co., Inc., New York, Toronto, London, 1959.
30. Strid, E. "Noise Measurements For Low-Noise GaAs FET Amplifiers," *Microwave Systems News*, Nov., 1981, pp. 62-70.
31. Strid, E. "Noise Measurement Checklist Eliminates Costly Errors," *Microwave Systems News*, Dec., 1981, pp. 88-107.
32. Swain, H. L. and R. M. Cox "Noise Figure Meter Sets Record for Accuracy, Repeatability, and Convenience," *Hewlett-Packard J.*, April, 1983, pp. 23-32.
33. van der Ziel, Aldert. "Noise: Sources, Characterization, Measurement", Pentice-Hall, Inc., Englewood Cliffs, New Jersey, 1970.
34. Wait, D.F., "Satellite Earth Terminal G/T Measurements," *Microwave Journal*, April, 1977, p. 49.

CHECKLIST, WATCH OUTS, BE CAREFULS, ADVICE FOR THE LEERY, WHOOPS

SUBJECT AREA	COMMON TROUBLE
EMI	Interference from TV, FM, nearby microprocessors, etc. Only single shield on IF cable (use double shield such as HP 11170A, B, or C if BNC). Unshielded HP-IB cable and/or connector. Unshielded HP-IB interface card on controller. Dirty or loose connectors. Uncovered circuitry. Transistor chips exposed to light. Dirty electromagnetic environment (shielded room needed?).
Connector Wear and Damage	Improper torque. Turning entire component to tighten connector. Mating with already worn connector.
Mismatch	High DUT S_{11} . High DUT S_{22} . High input SWR for measurement system. High noise source SWR. Large $ \Gamma_{hot} - \Gamma_{cold} $ for noise source (not a problem for DUT's with isolators).
Non-linearities	High spurious power, perhaps outside the measurement range, causing compression. Broad bandwidth causing high power and compression. DUT or measurement system not warmed up. Power supply drift. Oscillating DUT (probably outside measurement range). Regeneration somewhere. Gain too high (add attenuation at DUT output). Trying to measure a logarithmic amplifier.
Down converter	High mixer conversion loss. Mixer not balanced. Mixer diodes not well matched. High LO noise at the IF away from the LO frequency. Perhaps a preamp is needed for lower and constant system F. IF too high for mixer design. LO drive power too low. LO drive power drifts.
Loss of adapters, isolators, tuners, etc.	Improper available gain (should be $ S_{21} ^2 / (1 - S_{22} ^2)$). isolators, tuners, etc.
ENR calibration	Improper correction for isolator attached to noise source. Worn connector on noise source.
DSB or SSB	DUT G_a or F vary too much with frequency for DSB. System noise figure too high for SSB (perhaps use preamp).

